

Features & Benefits

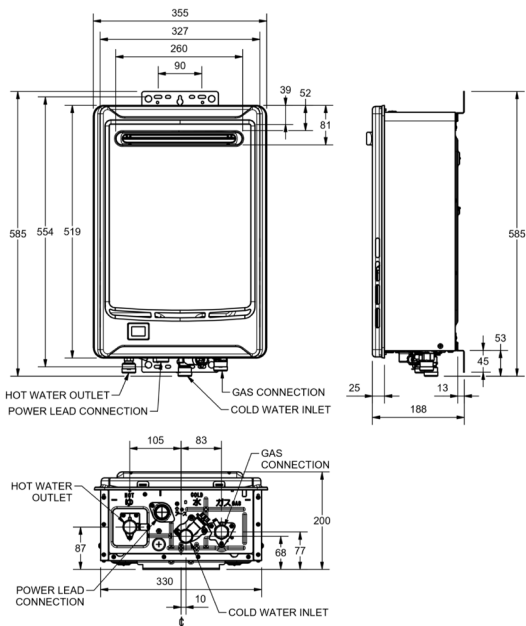

- 16 L/min continuous hot water delivery @ 25°C rise
- Remote Temperature Controller options
- 50°C models available (876A16), requiring no tempering valve¹
- LED display for easy fault diagnosis
- Natural gas & Propane models
- Accessories: Recess Box 299427
Security Cage 299867
Wall Mount Security Kit 299868
- 12 year heat exchanger warranty²



MODEL	876A16 874A16
Min. Operating Flow rate (L/min)	2.0
Nom. Gas Consumption (MJ/hr)	126
Max Water Supply Pressure (kPa)	1000
Min Water Supply Pressure (kPa)	120
Water Connections	R 3/4
Gas Connection	R 3/4
Approx. Weight (Empty) kg	16



¹ 60°C and higher temperature models and some applications require a tempering valve in accordance with AS 3500.4.

² See the Rheem warranty in the product's Owner's Guide or view product warranties at www.rheem.com.au/warranty