

Owners Guide and Installation Instructions



Solar Commercial Loline Water Heating System



Install a Rheem



WARNING: Plumber – Be Aware

Use copper pipe **ONLY**. Plastic pipe **MUST NOT** be used due to the effects of high water temperatures and pressures.

*This water heater must be installed and serviced by a qualified person.
Please leave this guide with a responsible officer.*



WARNING: Plumber – Be Aware

- The solar hot and solar cold pipes between the solar storage tank and the solar collectors **MUST BE** of copper. All compression fittings must use brass or copper olives.

There must be a continuous fall from the solar collectors to the solar storage tank. Horizontal runs of pipe work are acceptable and may be installed.

- Plastic pipe **MUST NOT** be used, as it will not withstand the temperature and pressure of the water generated by the solar collectors under stagnation conditions (up to 150°C and 1000kPa). Failure of plastic pipe can lead to the release of high temperature water and cause severe water damage and flooding.
- The full length of the solar hot and solar cold pipes **MUST BE** insulated.

The insulation must:

- be of a closed cell type or equivalent, suitable for a solar water heating application and capable of withstanding the temperature of the water generated by the solar collectors under stagnation conditions

The specification of the chosen insulation material should be checked with the insulation manufacturer prior to installation as different materials may vary in temperature tolerance.

- be at least 13 mm thick, however thicker insulation may be required to comply with the requirements of AS/NZS 3500.4
- be weatherproof and UV resistant if exposed
- extend through any penetrations in the eaves, ceiling and roof
- cover valves and fittings in the solar hot and solar cold pipe work
- be fitted up to the connections on the storage tank and the solar collectors.

Note: Failure to observe these requirements increases the risk of freeze damage and VOIDS ALL WARRANTY for freeze damage

Plumber: It is important to refer to and read in full the complete “Warning: Plumber – Be Aware” statement commencing on page 7.

PATENTS

This water heater may be protected by one or more patents or registered designs in the name of Rheem Australia Pty Ltd.

TRADE MARKS

® Registered trademark of Rheem Australia Pty Ltd.
™ Trademark of Rheem Australia Pty Ltd.

Note: Every care has been taken to ensure accuracy in preparation of this publication. No liability can be accepted for any consequences, which may arise as a result of its application

CONTENTS

PROPERTY OWNER – We recommend you read pages 4 to 25.
The other pages are intended for the installer but may be of interest.

Contents	3
About Your Water Heater	4
Regular Care	11
Water Supplies.....	15
Save A Service Call	19
installation - storage tanks	31
multiple installations	45
Installation – Solar Cold And Solar Hot Manifolds	50
Installation – Solar Collectors	53
Connections – Plumbing	68
Connections – Electrical	72
Rheem Solar Water Heater Warranty – Australia Only	90

ABOUT YOUR WATER HEATER

WATER HEATER APPLICATION

This water heater is designed for the purpose of heating potable water. Its use in an application other than this may shorten its life.

MODEL TYPE

Your Rheem commercial solar Loline™ water heater is designed for the solar collectors to be roof mounted and the solar storage tanks to be installed at ground or floor level. The Rheem solar storage tanks are suitable for installation either outdoor or indoor and with Rheem NPT 200 solar collectors. The system is not suitable for installation above 400 metres altitude.

The system when installed in areas subject to freeze conditions must be installed with the solar hot and solar cold pipes fully insulated with closed cell type insulation (minimum thickness 13 mm) and with an auxiliary electric water heater located in the solar cold line to offer protection against freeze damage. Freeze conditions occur below 6°C. The system has NO WARRANTY for freeze damage when installed above 400 metres altitude or if the solar hot and solar cold pipes are uninsulated or if an auxiliary electric water heater has not been installed.(refer to “[Warranty Exclusions](#)” on page 90 and to “[Pipe Work and Insulation](#)” on page 8).

Note: The Rheem warranty against freeze damage applies only to systems installed in Australia.

SOLAR OPERATION

The Rheem Loline open circuit system has its vitreous enamel lined solar storage tank installed at ground or floor level, remotely from the solar collectors.

As the sun heats the water in the solar collectors the increase in temperature activates the circulator. The circulator then moves the water from the solar collectors through an insulated pipe to the solar storage tank. The circulator switches on whenever the water in the solar collectors is hotter than the water in the tank. Cooler water from the solar storage tank is circulated to the solar collectors to be heated by the sun’s energy. This process continues while solar energy is available and until the water in the solar storage tank reaches a temperature of 70°C to 80°C. Automatic safety controls are fitted to the water heater to provide safe and efficient operation.

MAINS PRESSURE

The water heater is designed to operate at mains pressure by connecting directly to the mains water supply. If the mains supply pressure in your area exceeds that [shown on page 31](#), a pressure limiting valve must be fitted.

ABOUT YOUR WATER HEATER

The supply pressure should be greater than 350 kPa for true mains pressure operation to be achieved. A minimum water supply pressure equivalent to the static head to the water inlet is required to enable the solar circulator and solar circuit system to operate effectively.

HOW HOT SHOULD THE WATER BE?

The solar control unit will circulate water through the solar collectors until a temperature of approximately 75°C is reached. During periods of low solar energy gain, the water temperature will be automatically boosted by the in-series booster water heater(s). Refer to the Owners Guide and Installation Instructions supplied with the booster water heater(s).

To meet the requirements of the National Plumbing Standard the solar water heating system must have means to limit the growth of Legionella bacteria. Therefore it is necessary to have in-series booster water heaters as part of the installation.

Rheem recommends the thermostat(s) of the in-series water heater(s) are adjusted to the lowest setting which meets your needs

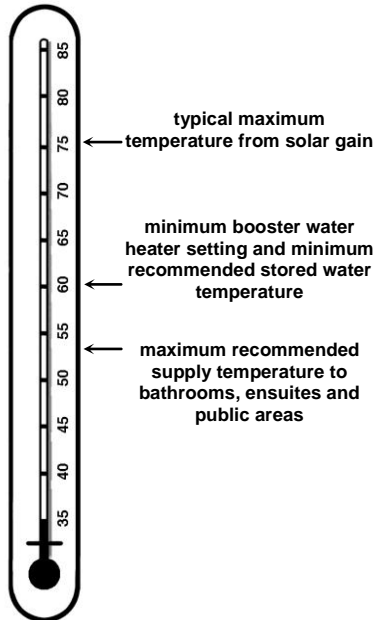

ABOUT YOUR WATER HEATER

HOTTER WATER INCREASES THE RISK OF SCALD INJURY

This water heater can deliver water at temperatures which can cause scalding. Check the water temperature before use, such as when entering a shower or filling a bath or basin, to ensure it is suitable for the application and will not cause scald injury.

We recommend and it may also be required by regulations that an approved temperature limiting device be fitted into the hot water pipe work to the bathing and public areas when this water heater is installed. This will keep the water temperature below the maximum permitted by AS/NZS 3500.4 to these areas. The risk of scald injury will be reduced and still allow hotter water to the kitchen, laundry and other areas requiring sanitising temperatures.

TEMPERATURE ADJUSTMENT

The in-series booster water heater(s) feature adjustable thermostat(s). They may require a licensed tradesperson to make any temperature adjustments. The thermostat(s), depending upon the model of water heater, has a maximum temperature setting of between 65°C and 82°C and a minimum temperature setting of 60°C.

We advise the thermostat(s) of the in-series water heater(s) are adjusted to the lowest setting which meets your needs, especially if there are young children or elderly people in the premises. Refer to “[Hotter Water Increases the Risk of Scald Injury](#)” on page 6.

PRECAUTIONS

Where damage to property can occur in the event of the water heater leaking, the water heater must be installed in a safe tray or within suitably drained bunding. Construction, installation and draining of a safe tray must comply with AS/NZS 3500.4 and all local codes and regulatory authority requirements.

The water heater must be maintained in accordance with the Owner’s Guide and Installation Instructions. Refer to “[Regular Care](#)” on page 11.

If this water heater is to be used where an uninterrupted hot water supply is necessary for your application or business you should ensure that you have redundancy within the hot water system design. This should ensure the continuity of hot water supply in the event that this water heater was to become inoperable for any reason. We recommend you seek advice from your plumber or specifier about your needs and building back up redundancy into your hot water supply system.

ABOUT YOUR WATER HEATER

WARNING

This water heater is only intended to be operated by persons who have the experience or the knowledge and the capabilities to do so. This water heater is not intended to be operated by persons with reduced physical, sensory or mental capabilities i.e. the infirm, or by children. Children should be supervised to ensure they do not interfere with the water heater.

This water heater uses 240 V AC electrical power for operation of the control systems and the electrically operated components. The removal of the solar controller or circulator covers will expose 240 V wiring. They must only be removed by a qualified person.

The power lead from the solar controller must be plugged into a weatherproof electrical outlet if installed outdoors. Take care not to touch the power plug with wet hands.

Care should be taken not to touch the pipe work connecting the solar storage tanks and the solar collectors. Very high temperature hot water can be generated by the solar collectors under certain conditions and flow through the pipe work from the solar collectors to the solar storage tanks.

Note: Any exposed pipe work or fittings in the solar circuit should be covered with insulation. Phone Rheem Service or their nearest Accredited Service Agent to arrange for an inspection.

SAFETY

Each solar storage tank is supplied with a combination temperature pressure relief valve. This device must not be tampered with or removed. The solar water heating system must not be operated unless each of these devices is fitted and is in working order.

If the power supply cord or plug to the solar control unit or the electrical conduit to the circulator(s) is damaged, it must be replaced by a qualified person in order to avoid a hazard. The power supply cord and plug must be replaced with a genuine replacement part available from Rheem. Phone your nearest Rheem Service Department or Accredited Service Agent to arrange for an inspection.

 **Warning:** For continued safety of this water heater it must be installed, operated and maintained in accordance with the Owner's Guide and Installation Instructions.

The Rheem warranty may not cover faults if relief valves or other safety devices are tampered with or if the installation is not in accordance with these instructions.

ABOUT YOUR WATER HEATER

FREEZE PROTECTION

The system, when installed in areas subject to freeze conditions, must be installed with the solar hot and solar cold pipes fully insulated (minimum thickness 13 mm) and with the frost sensor installed in the bottom of the collector array and an auxiliary electric water heater located in the solar cold line to offer protection against freeze damage. Freeze conditions occur below 6°C. The system has NO WARRANTY for freeze damage when installed above 400 metres altitude or if the solar hot and solar cold pipes are uninsulated or if the frost sensor and /or an auxiliary electric water heater has not been installed. (refer to “**Warranty Exclusions**” on page 90 and to “**Pipe Work and Insulation**” on page 8).

The anti freeze control is designed to recirculate a small amount of water from the solar storage tanks through the solar pipe work during periods of low temperatures. This is to prevent the water inside the pipe work from freezing. If insufficient energy is available in the solar storage tanks, the auxiliary electric water heater will be energised to provide sufficient protection of the solar collectors. It is essential that the electrical circuit to the solar control unit, circulator(s) and auxiliary electric heater is continually turned on if there is a risk of freezing. The solar warranty does not cover damage caused by freeze conditions when the electrical circuit to the solar control unit, circulator(s) and auxiliary electric heater is turned off or interrupted.

PIPE WORK AND INSULATION

The solar hot and solar cold pipe work between the solar storage tank and the solar collectors and between the solar storage tank and in-series booster **MUST BE** of copper. All compression fittings must use brass or copper olives. Plastic pipe **MUST NOT** be used, as it will not withstand the temperature and pressure of the water generated by the solar collectors under stagnation conditions.

We recommend you read the Warning Plumber on page 2 for full details regarding pipe work and insulation requirements.

TO TURN OFF THE WATER HEATING SYSTEM

If it is necessary to turn off the water heating system:

- Switch off the electrical supply at the power outlet to the solar control unit (refer to note below). Isolate the power to the auxiliary electric heater, where fitted, at the isolating switch.
- Close the cold water isolation valve on the cold water line to the solar storage tanks to shut down the entire system, or;

ABOUT YOUR WATER HEATER

- Close the isolation valves on the cold, hot and solar hot water branches to shut down an individual solar storage tank in a bank, or;
- Close an isolation valve at each circulator and close the isolation valve at each solar hot water branch to each solar storage tank to isolate the solar collectors only.
- Open the solar cold pipe or solar hot pipe drain isolation valve if one is installed.
- Refer to the owner's manual supplied with the booster water heaters for shut down procedure of the booster water heaters, if shut down is required.

⚠ Warning: The solar collectors should only be isolated if a solar cold pipe drain isolation valve and / or an air bleed valve are installed and at least one of them is opened, if the collectors are to be drained or serviced.

Note: If there is a risk of freezing conditions, the electrical supply to the solar control unit and auxiliary electric heater should not be switched off unless the solar collectors are drained, otherwise damage could result (refer to “Freeze Protection” on page 8).

TO TURN ON THE WATER HEATING SYSTEM

- Ensure the solar cold pipe drain isolation valve and the air bleed valve are closed and the circulator isolation valves are open.
- Open the isolation valves on the cold, hot and solar hot water branches at each solar storage tank and on the auxiliary electric heater, if installed.
- Open the cold water isolation valve fully on the cold water line to the solar storage tanks.
- If the solar collectors and solar hot and solar cold pipes have been drained, it will be necessary to bleed the collector circuit (refer to “Bleeding the Solar Collectors” on page 78).
- Switch on the electrical supply at the power outlet to the solar control unit, auxiliary electric heater (if fitted) and circulator(s).

The power outlet must be switched on for the solar control unit to operate and solar gain to be achieved.

- Refer to the owner's manual supplied with the booster water heaters for procedure to turn on the booster water heaters.

ABOUT YOUR WATER HEATER

HOW DO I KNOW IF THE WATER HEATER IS INSTALLED CORRECTLY?

Installation requirements are shown on page 29 to 49. The water heater must be installed:

- by a qualified person, and
- in accordance with these instructions and the instructions supplied with any components of the system, and
- in compliance with Standards AS/NZS 3500.4, AS/NZS 3000, AS/NZS 5601.1 and all local codes and regulatory authority requirements.

In New Zealand, the installation must also conform with the New Zealand Building Code.

VICTORIAN CUSTOMERS

Notice to Victorian Customers from the Victorian Building Authority. This water heater must be installed by a licensed person as required by the Victorian Building Act 1993.

Only a licensed person will give you a Compliance Certificate, showing that the work complies with all the relevant Standards. Only a licensed person will have insurance protecting their workmanship for 6 years. Make sure you use a licensed person to install this water heater and ask for your Compliance Certificate.

DOES THE WATER CHEMISTRY AFFECT THE WATER HEATER?

The water heater is suitable for most public water supplies, however some water chemistries may have detrimental effects on the water heater, its components and fittings. Refer to “Water Supplies” on page 15. If you are not sure, have your water chemistry checked against the conditions described on page 18

HOW LONG WILL THE WATER HEATER LAST?

Your water heater is supported by a manufacturer’s warranty (refer to page 90). There are a number of factors that will affect the length of service the water heater will provide. These include but are not limited to the water chemistry, the water pressure, temperature (inlet and outlet) and the water usage pattern. Refer to “Precautions” on page 6.

REGULAR CARE

MINOR SIX MONTH MAINTENANCE

It is recommended minor maintenance be performed every six months by a responsible officer.

The minor maintenance includes:

- Operate the easing lever on the pressure relief valve. It is very important you raise and lower the lever gently. Refer to “[Pressure Relief Valve](#) and [Expansion Control Valve](#)” on page 13.

 **Warning:** Exercise care to avoid any splashing of water, as water discharged from the drain line will be hot. Stand clear of the drain line’s point of discharge when operating the valve’s lever.

- Operate the easing lever on the expansion control valve (if fitted). It is very important you raise and lower the lever gently. Refer to “[Pressure Relief Valve](#) and [Expansion Control Valve](#)” on page 13.
- Have the auxiliary electric heater (if installed) checked for performance before winter by a qualified electrician.

MAJOR FIVE YEAR SERVICE

It is recommended a major five year service be conducted on the water heater.

 **Warning:** Servicing of a water heater must only be carried out by a qualified person. Phone Rheem Service or their nearest Accredited Service Agent.

Note: The five year service and routine replacement of any components, such as the anode and relief valve(s), are not included in the Rheem warranty. A charge will be made for this work. Only genuine replacement parts should be used on this water heater.

The major service includes:

- Replace the temperature pressure relief valve.
- Inspect and flush the expansion control valve (if fitted). If required, replace the valve.
- Inspect and if required, replace the anode(s).

If the anode is not replaced, it should be replaced within three years of this service (refer to “[Anode Inspection and Replacement](#)” on 16).

- Check the solar control unit for correct operation.
- Flush and bleed the solar collectors.

REGULAR CARE

- Clean the collector glass.
- Check the insulation on the solar hot and solar cold pipes. If required, insulate exposed pipe work and repair or replace degraded insulation.
- Visually check the unit for any potential problems.
- Inspect all connections.
- Check the drain line from the safe tray (if one is installed) is not blocked.

Note: The water heater may need to be drained during this service. After the completion of the service, the water heater will take some time to reheat the water. Depending upon the power supply connection, hot water may not be available until the next day.

TEMPERATURE PRESSURE RELIEF VALVE

This valve is near the top of the solar storage tank and is essential for its safe operation. It is possible for the valve to release a little water through the drain line during each heating period. This occurs as the water is heated and expands by approximately 1/50 of its volume.

Continuous leakage of water from the valve and its drain line may indicate a problem with the water heater (refer to “**Temperature Pressure Relief Valve Running**” on page 21).

⚠ Warning: Never block the outlet of this valve or its drain line for any reason.

Operate the easing lever on the temperature pressure relief valve once every six months. **It is very important you raise and lower the lever gently.**

⚠ DANGER: Failure to do this may result in the water heater cylinder failing, or under certain circumstances, exploding.

⚠ Warning: Exercise care to avoid any splashing of water, as water discharged from the drain line will be hot. Stand clear of the drain line’s point of discharge when operating the valve’s lever.

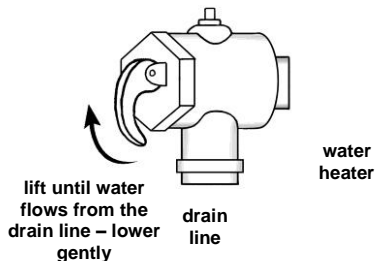
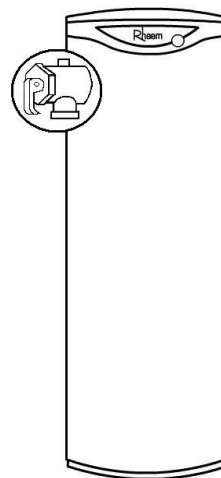

REGULAR CARE

If water does not flow freely from the drain line when the lever is lifted, then the water heater must be checked. Phone Rheem Service or their nearest Accredited Service Agent to arrange for an inspection.

The temperature pressure relief valve should be checked for performance or replaced at intervals not exceeding 5 years, or more frequently in areas where there is a high incidence of water deposits (refer to "Water Supplies" on page 15).

EXPANSION CONTROL VALVE

In many areas, including South Australia, Western Australia and scaling water areas, an expansion control valve is fitted to the cold water line to the water heater. The expansion control valve may discharge a small quantity of water from its drain line during the heating period instead of the temperature pressure relief valve on the water heater.

Operate the easing lever on the expansion control valve once every six months. **It is very important you raise and lower the lever gently.** The expansion control valve should be checked for performance or replaced at intervals not exceeding 5 years, or more frequently in areas where there is a high incidence of water deposits.

COLLECTOR GLASS

Ensure the glass on your solar collectors is free of dust, salt spray or any other matter, which may reduce the effectiveness of the solar collectors. If the collector glass becomes dirty, hose down or if the solar collectors are accessible, wash the collector glass with water and a soft brush when the solar collectors are cool.

Have any trees trimmed which may shade the solar collectors.

Rheem solar collectors have passed the AS/NZS 2712 requirements for resistance to hailstone damage, so it is not normally necessary to fit a guard to a collector.

REGULAR CARE

FLUSHING THE SOLAR COLLECTORS

It may be necessary to flush the solar collectors if there is sediment in the water supply. This should be conducted in the morning, within three hours of sunrise.

- Open a hot water tap and allow the water to run for five (5) minutes prior to flushing the solar collector(s).
- Close the hot tap.
- Wait a further five (5) minutes before attempting to flush the solar collectors.

This will assist in the transfer of any high temperature water in the solar collector(s) to the solar storage tank.

⚠ Warning: Exercise care, as water discharged from the solar collectors may be of a very high temperature.

- To flush the solar collectors, follow the procedure “[Bleeding the Solar Collectors](#)” on page 78, allowing the water to flow from the air bleed valve drain line on the solar hot pipe (from the solar collectors) for five minutes before closing the bleed valve. It is recommended to flush the solar collectors every five years. This will assist in keeping the solar collectors, solar hot pipe and solar cold pipe clear of sediment.

WATER SUPPLIES

This water heater must be installed in accordance with this advice to be covered by the Rheem warranty.

This water heater is manufactured to suit the water conditions of most public reticulated water supplies. However, there are some known water chemistries which can have detrimental effects on the water heater and its operation and / or life expectancy. If you are unsure of your water chemistry, you may be able to obtain information from your local water supply authority. This water heater should only be connected to a water supply which complies with these guidelines for the Rheem warranty to apply.

CHANGE OF WATER SUPPLY

The changing or alternating from one water supply to another can have a detrimental effect on the operation and / or life expectation of a water heater cylinder, a temperature pressure relief valve, a heating unit and a solar collector in a direct solar water heating system.

Where there is a changeover from one water supply to another, e.g. a rainwater tank supply, bore water supply, desalinated water supply, public reticulated water supply or water brought in from another supply, then water chemistry information should be sought from the supplier or it should be tested to ensure the water supply meets the requirements given in these guidelines for warranty to apply.

ANODE

The vitreous enamel lined cylinder of the water heater is covered by the Rheem warranty when the total dissolved solids (TDS) content in the water is less than 2500 mg/L and when the correct colour coded anode is used. If an incorrect colour coded anode is used in the water heater, any resultant faults will not be covered by the Rheem warranty. In addition, the use of an incorrect colour coded anode may shorten the life of the water heater cylinder.

The correct colour coded anode must be selected and fitted to the water heater in accordance with the following advice and the [Anode Selection chart](#) on page 16 for warranty to apply to the water heater cylinder.

WATER SUPPLIES

Total Dissolved Solids	Anode Colour Code
0 – 40 mg/L	Green
40 – 150 mg/L	Green or Black
150 – 400 mg/L	Black
400 – 600 mg/L	Black or Blue
600 – 2500 mg/L	Blue
2500 mg/L +	Blue (no cylinder warranty)

The changing of anodes must be carried out by a qualified person.

Note: Some water analysis reports may state the conductivity of the water rather than the level of total dissolved solids. Conductivity, measured in microsiemens per centimetre ($\mu\text{S} / \text{cm}$), is directly proportional to the TDS content of the water. TDS, in mg / L , is approximately 70% of the conductivity in $\mu\text{S} / \text{cm}$.

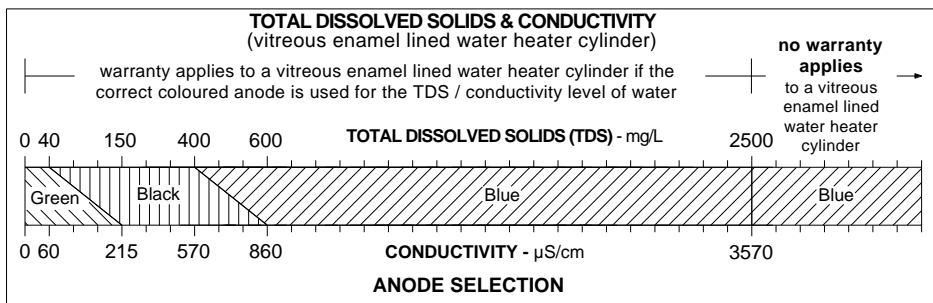

ANODE INSPECTION AND REPLACEMENT

The anode installed in your water heater will slowly dissipate whilst protecting the cylinder. The life of the cylinder may be extended by replacing the anode.

If the anode is not replaced during a five year service (refer to “Major Five Year Service” on page 11) then the maximum time after installation when the anode should be replaced is 8 years.

For water supplies which are either softened, desalinated or where the water supply may alternate between a water tank and a reticulated public supply or another supply, it is recommended the anode be replaced within 5 years of installation.

WATER SUPPLIES

CAUTION

If the water supply has a TDS greater than 150 mg/L and a green anode has not been changed to a black anode, or if the TDS is greater than 600 mg/L and the anode has not been changed to a blue anode, there is the possibility the anode may become overactive and hydrogen gas could accumulate in the top of the water heater during long periods of no use.

If, under these conditions, the water heater has not been used for two or more weeks the following procedure should be carried out before using any electrical appliances (automatic washing machines and dishwashers) which are connected to the hot water supply.

The hydrogen, which is highly flammable, should be vented safely by opening a hot tap and allowing the water to flow. There should be no smoking or naked flame near the tap whilst it is turned on. Any hydrogen gas will be dissipated. This is indicated by an unusual spurting of the water from the tap. Once the water runs freely, any hydrogen in the system will have been released.

SATURATION INDEX

The saturation index is used as a measure of the water's corrosive or scaling properties.

In a corrosive water supply, the water can attack copper parts and cause them to fail.

Where the saturation index is less than -1.0 , the water is very corrosive and the Rheem warranty does not apply to a copper sheathed heating unit or to a solar collector in a direct solar water heating system. A corrosion resistant heating unit must be used for the Rheem warranty to apply to the heating unit.

In a scaling water supply calcium carbonate is deposited out of the water onto any hot metallic surface.

Where the saturation index exceeds $+0.40$, the water is very scaling. An expansion control valve must be fitted on the cold water line after the non-return valve to protect and for the Rheem warranty to apply to the temperature pressure relief valve and water heater cylinder. Solar collectors in a direct solar water heating system should be covered when the water heater is not intended to be used for more than two weeks.

Where the saturation index exceeds $+0.80$, the Rheem warranty does not apply to a standard watts density heating unit or to a solar collector in a direct solar water heating system. A low watts density heating unit must be used for the Rheem warranty to apply to the heating unit.

Water which is scaling may be treated with a water softening device to reduce the saturation index of the water.

WATER SUPPLIES

Refer to the [Saturation Index chart](#) on page 18.

Contact Rheem Service or their nearest Accredited Service Agent if a replacement heating unit is required.

Refer to the [cold water connection detail](#) on page 32 for the position of the expansion control valve.

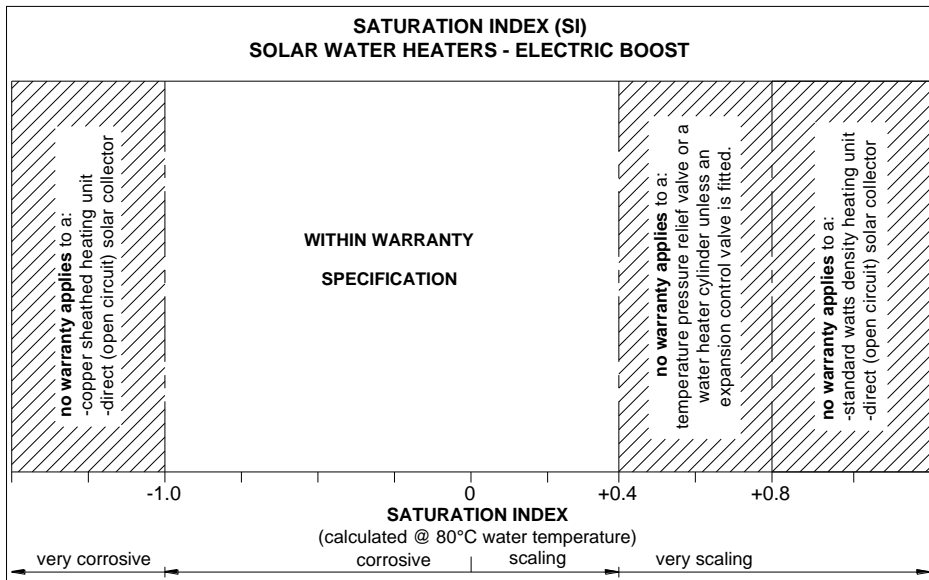

SUMMARY OF WATER CHEMISTRY ADVICE AFFECTING WARRANTY

The water heater and its components are not suitable for certain water chemistries. Those chemistries are listed below. If the water heater is connected at any time to a water supply with the following water chemistry, the Rheem warranty will not cover any resultant faults on the components listed below:

Water Chemistry

- Total Dissolved Solids (TDS) > 2500 mg/L
- Total Dissolved Solids (TDS) not suitable for anode type
- Saturation Index (SI) < -1.0
- Saturation Index (SI) > +0.4
(if an expansion control valve is not fitted)
- Saturation Index (SI) > +0.8

Component

- water heater cylinder
- water heater cylinder
- solar collector
- water heater cylinder
- temperature pressure relief valve
- solar collector

SAVE A SERVICE CALL

Check the items below before making a service call. You will be charged for attending to any condition or fault that is not related to manufacture or failure of a part.

NOT ENOUGH HOT WATER (OR NO HOT WATER)

- **Insufficient sunlight**

Insufficient sunlight due to cloudy weather during summer months or low solar energy contribution in winter months may mean the booster water heaters will operate more often.

- **Booster water heaters(s) not operating**

Check the operation of the in-series booster water heater(s) to ensure they are operating correctly. Refer to the Owners Guide and Installation Instructions supplied with the water heater(s).



- **Solar Control Unit**

Check the power outlet for the solar control unit is switched on.

- **Collectors shaded**

If trees or other objects shade the solar collectors or if the glass is dirty, the effectiveness of the solar collectors will be greatly reduced. Have the trees trimmed or the solar collectors relocated if the obstruction is permanent or clean the collector glass (refer to “Collector Glass” on page 13).

- **Collector area is too small**

For most installations, the number of solar collectors recommended in Rheem literature has been proven to provide the required solar energy to meet the hot water requirements. However, in some circumstances, it may be necessary to install additional solar collectors.

- **Air in collectors (no solar gain)**

It is possible under certain conditions, such as when the pipe work has been opened, that air may become trapped in the solar collectors. This will prevent the circulator from moving water around the collector circuit. The air

SAVE A SERVICE CALL

will need to be purged from the solar collectors (refer to “[Bleeding The Solar Collectors](#)” on page 78).

- **Are you using more hot water than you think?**

Are outlets (especially the showers) using more hot water than you think? Very often it is not realised the amount of hot water used, particularly when showering. Carefully review the hot water usage. Have your plumber install a flow control valve to each shower outlet to reduce water usage.

- **Temperature pressure relief valve running**

Is the relief valve discharging too much water? (Refer to “[Temperature Pressure Relief Valve Running](#)” on page 21).

- **Thermostat setting**

Ensure the thermostat setting on the booster water heater(s) is appropriate. You may choose to have the thermostats adjusted upwards by a qualified person to gain additional hot water capacity when boosting.

 **Warning:** Hotter water increases the risk of scald injury.

- **Water heater size**

Do you have the correct size booster water heaters for your requirements? The sizing guides in the sales literature and on the Rheem website (www.rheem.com.au) suggests average sizes that may be needed.

WATER NOT HOT ENOUGH

You may find that due to low solar energy gain the water temperature from the solar storage tanks may be lower than normally expected. The water temperature will be boosted by the in series booster water heater(s).

COLLECTOR GLASS

Warranty **DOES NOT** cover breakage of solar collector glass.

 **Warning:** No attempt should be made to remove or replace broken collector glass.

The collector glass is not offered as a replacement part. Should the solar collector require replacement, contact your nearest Rheem Service Department or Accredited Service Agent.

SAVE A SERVICE CALL

TEMPERATURE PRESSURE RELIEF VALVE RUNNING

- **Normal Operation**

It is normal and desirable this valve allows a small quantity of water to escape during the heating cycle. However, if it discharges more than a bucket full of water in 24 hours, there may be another problem.

- **Continuous dribble**

Try gently raising the easing lever on the relief valve for a few seconds (refer to “[Temperature Pressure Relief Valve](#)” on page 12). This may dislodge a small particle of foreign matter and clear the fault. Release the lever gently.

- **Steady flows for long period (often at night)**

This may indicate the mains water pressure sometimes rises above the designed pressure of the water heater. Ask your installing plumber to fit a pressure limiting valve.

⚠ Warning: Never replace the relief valve with one of a higher pressure rating.

- **Heavy flows of hot water until the water heater is cold - then stops until water reheats**

The water heating system **must** be switched off at the isolating switch. Phone your nearest Rheem Service Department or Accredited Service Agent to arrange for an inspection.

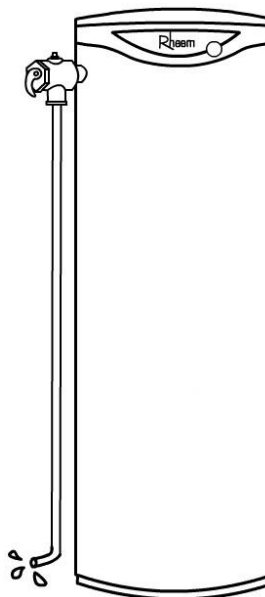

EXPANSION CONTROL VALVE RUNNING

If an expansion control valve is fitted in the cold water line to the water heater ([refer to page 68](#)) it may discharge a small quantity of water instead of the temperature pressure relief valve on the water heater. The benefit is that energy is conserved as the discharged water is cooler.

SAVE A SERVICE CALL

SOLAR MONITOR

The LEDs on the Solar Monitor, located on the side of the solar control unit, operate to show the operational mode of the water heater (refer to page 80) for further details. Note the colour and number of flashes if making a service call.

- **Green LED Is Not Illuminated On Solar Monitor**

Check the power outlet for the solar control unit is switched on.

If the power outlet for the solar control unit is switched on, switch off for a few seconds and then switch on again. If the green LED remains off there may be a fault with the water heater. Phone Rheem Service or their nearest Accredited Service Agent to arrange for an inspection.

- **Red LED Illuminated on Solar Monitor**

The illumination of the red LED does not necessarily mean there is a fault with the system. A constant glow or rapid flashing of the red LED indicates an operational mode of the water heater.

Constant Glow: When the water heater has entered Over-temperature operation (refer to page 23) , the water in the solar collectors will continue to gain heat whilst solar energy is still available. The red LED will glow continuously when sufficient solar energy has been received to activate the circulator. This indicates a build up in temperature of the water in the solar collectors and does not represent a fault. The red LED will stop glowing when the circulator has moved the excess energy from the solar collectors to the solar storage tank.

When eight Over-temperature cycles have been completed, and if solar energy is still available, the red LED will glow continuously until either a reasonable quantity of hot water is drawn from a tap or the water in the solar collectors loses energy and cools as the available solar energy is reduced, such as when the sun becomes lower in the sky in the late afternoon / early evening or the sky becomes very cloudy.

Rapid Flashing: During Normal operation the red LED will flash rapidly if the temperature difference between the hot sensor and cold sensor is high due to excess heat in the solar collectors. This may not represent a fault. The rapid flashing of the red LED will cease as the water circulates, transferring the excess heat from the solar collectors to the solar storage tank and the temperature difference between the hot sensor and cold sensor reduces. This should be within four (4) to five (5) minutes, but may take up to ten (10) minutes.

SAVE A SERVICE CALL

If the red LED continues to flash rapidly for longer than ten (10) minutes, switch off the electrical supply at the power outlet to the solar control unit for a few seconds, then switch on again. If the red LED continues flash rapidly for longer than ten (10) minutes, phone Rheem Service or their nearest Accredited Service Agent to arrange for an inspection.

Series of Flashes: The red LED may emit groups of three to six flashes with a 2 second interval between groups. This indicates there may be a fault with the water heater.

If the red LED emits groups of flashes, switch off the electrical supply at the power outlet to the solar control unit for a few seconds, then switch on again. If the red LED illuminates again, then count the number of flashes and phone Rheem Service or their nearest Accredited Service Agent to arrange for an inspection.

CIRCULATOR OPERATES AT NIGHT

The circulator can operate during periods of no solar energy, usually at night, under two operational modes of the water heater. This is by design and does not indicate a fault.

Freeze Protection Operation: The circulator will activate (green LED flashes rapidly or in groups of 3) if the water temperature in the solar collectors approaches freezing point. This occurs in very cold conditions, such as overnight and very early in the morning before sunrise. The purpose of the Freeze Protection operation is to prevent freezing of water in the solar collectors and solar pipe work. The circulator will remain on for some minutes and until the hot sensor measures a water temperature at a safe level above freezing from the storage tank. This process will repeat whenever the water temperature in the solar collectors approaches freezing point.

Over-temperature Operation: The purpose of the Over-temperature operation is to reduce the amount of overheating or 'stagnation' of water in the solar collectors. When the water in the solar storage tank has reached 70°C to 75°C and the circulator has deactivated, the solar collectors will continue to gain heat while solar energy is still available.

If the water in the solar collectors stagnates and its temperature becomes very high, the circulator will activate for a short period to transfer this extra energy to the solar storage tank. The circulator will deactivate when the water temperature in the solar collectors decreases. This process will either repeat for a maximum of eight cycles or until the water temperature in the solar storage tank reaches around 75°C to 80°C.

SAVE A SERVICE CALL

Night Time Cooling Operation: The circulator will activate (green LED flashes rapidly or in groups of 3) if the water heater has entered Over-temperature operation during that day. This can occur during periods of higher solar energy or lower hot water usage. Excess solar energy gained will be dissipated through the solar collectors until the water temperature in the solar storage tank decreases to a desired 60°C to 70°C. The circulator may remain on for some time..

NOISE FROM THE SOLAR COLLECTORS

When solar radiation is high or hot water usage is low, the water heater may undergo over-temperature operation (refer to “Over-temperature operation” on page 23). If this mode of operation has occurred and the circulator has deactivated, the water in the solar collectors will continue to gain heat and increase in temperature when solar radiation is still available. This increase in temperature is greater when higher performing selective surface solar collectors are installed compared to non-selective surface collectors.

When a hot tap is opened, the pressure in the system is released and the high temperature water may turn to steam creating a sudden and loud rumbling noise and even a rattling or banging noise of the solar collectors against the roof cladding material. This results from the higher level of solar radiation and the water in the solar storage tank being at its maximum temperature and is not caused by a fault with the solar water heater.

SAVE A SERVICE CALL

HIGH ENERGY BILLS

With the installation of your new solar water heating system, maximum energy savings can be achieved with careful planning of hot water usage. Should you at any time, feel your energy account is too high, we suggest you check the following points:

- Is the relief valve running excessively? (Refer to “Temperature Pressure Relief Valve Running” on page 21).
- Are outlets (especially the showers) using more hot water than you think? (Refer to “Not Enough Hot Water” on page 19).
- Is there a leaking hot water pipe, dripping hot water taps, etc? Even a small leak will waste a surprising quantity of hot water and energy. Replace faulty tap washers, and have your plumber rectify any leaking pipe work.
- Are the booster water heaters being utilised properly? (Refer to the Owners Guide and Installation Instructions supplied with the booster water heaters).
- Consider recent changes to the hot water usage pattern and check if there has been any increase in tariffs since your previous account.

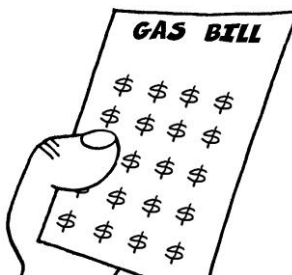
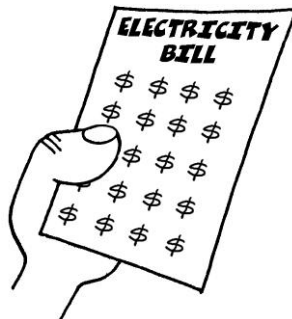

ENERGY TARIFFS

The energy tariff to which your booster water heater(s) is connected will play an important role in the overall effectiveness of the system. It is important you are aware of this tariff to enable you to take full advantage of the energy savings.

IF YOU HAVE CHECKED ALL THE FOREGOING AND STILL BELIEVE YOU NEED ASSISTANCE, CALL YOUR NEAREST RHEEM SERVICE DEPARTMENT OR ACCREDITED SERVICE AGENT.

INSTALLATION –SYSTEM

THIS WATER HEATER IS NOT SUITABLE FOR POOL HEATING

INSTALLATION STANDARDS

The water heater must be installed:

- by a qualified person, and
- in accordance with the installation instructions, and
- in accordance with the requirements of Standards AS/NZS 3500.4, AS/NZS 3000, AS/NZS 5601.1 and all local codes and regulatory authority requirements.

In New Zealand, the installation must conform with the New Zealand Building Code.

Victorian Installers

Notice to Victorian Installers from the Victorian Building Authority if this solar water heater is installed in a new Class 1 dwelling in the State of Victoria. The system model number is to be recorded on the Certificate of Compliance. It is also a requirement to provide the householder with permanent documentation recording the system model number exactly as it is shown in the 'List of systems capable of complying with the regulations' published by Sustainability Victoria (see www.sustainability.vic.gov.au). This documentation may be in the form of an indelible label adhered to the solar storage tank, or other suitable form placed in an accessible location, such as the meter box, for later inspection.

WATER HEATER APPLICATION

This water heater is designed for the purpose of heating potable water. Its use in an application other than this may shorten its life

If this water heater is to be used where an uninterrupted hot water supply is necessary for the application or business, then there should be redundancy within the hot water system design. This should ensure the continuity of hot water supply in the event that this water heater was to become inoperable for any reason. We recommend you provide advice to the system owner about their needs and building redundancy into the hot water supply system.

INSTALLATION –SYSTEM

GENERAL

The following requirements apply to the installation of Rheem Commercial Solar Loline Systems:

- Suitable Solar Collectors – NPT 200
- Maximum Altitude – 400m
- Solar hot and cold pipes to be fully insulated with closed cell insulation (13mm minimum thickness). Thicker insulation may be required to comply with the requirements of AS/NZS 3500.4.
- When installed in areas subject to freeze conditions (ie below 6°C):
 - Auxiliary electric water heater to be installed in solar cold line.
 - Frost sensor to be installed in the bottom of the collector array

The system has **NO WARRANTY** for freeze damage if the above conditions have not been met. (refer to “**Warranty Exclusions**” on page 90 and to “**Warning: Plumber Be Aware**” on page 2).

TYPICAL INSTALLATION

Typical installations are shown on pages 29 to 30. All Rheem Commercial Solar Loline installations will include the following:

- One or more solar storage tanks
- Two or more solar collectors
- A solar control unit
- A solar circulator (or dual solar circulator set)
- One or more in line booster water heaters

In addition, the following optional features may apply:

- In areas subject to freeze conditions, an auxiliary electric water heater installed in solar cold line. Refer to page 50
- A motorised three way by-pass valve to circulate building return water through the solar tank when sufficient energy is available. Refer to page 68

Collectors may be installed on a pitched roof or on a flat roof with stand

INSTALLATION –SYSTEM

Important:

- Working on roofs is and should always be considered a hazardous activity, particularly early in the morning, late in the evening, when the roof is wet or during and after periods of rain.
- All work must be carried out in accordance with Local, State and Federal Occupational Safety, Health and Welfare Regulations. In particular, the requirements for safety whilst manual lifting, working at heights and on roofs.
- Installers must be competently trained in:
 - Height Hazard Assessment
 - Working at Height Procedures
 - Assessment / Use / Wearing of correct height safety equipment (harnesses etc.)
 - All other relevant safety factors specific to the installation and maintenance work to be compliant with suitable Occupational, Health and Safety Regulations / Codes.
- All relevant permits shall be obtained from the regulatory authorities before commencing work to install the solar hot water system.
- All work carried out must be performed by appropriately qualified tradespeople or be suitably supervised for trades assistant duties.
- Every care must be taken to protect and warn occupants of the building and the public from personal injury which may occur from falling tools, roof materials, fittings or any other hazards of a general nature.
- Advise the occupants of any inconvenience which may occur due to disconnection of existing water and electrical supplies.
- The connection, attachment, integration or general association of other equipment or parts which either directly or indirectly affect the operation or performance of this equipment could void the Rheem warranty.
- All packaging materials must be removed from the water heater prior to its installation. This includes the removal of the cardboard base of the carton from the underside of the water heater.

INSTALLATION – SYSTEM

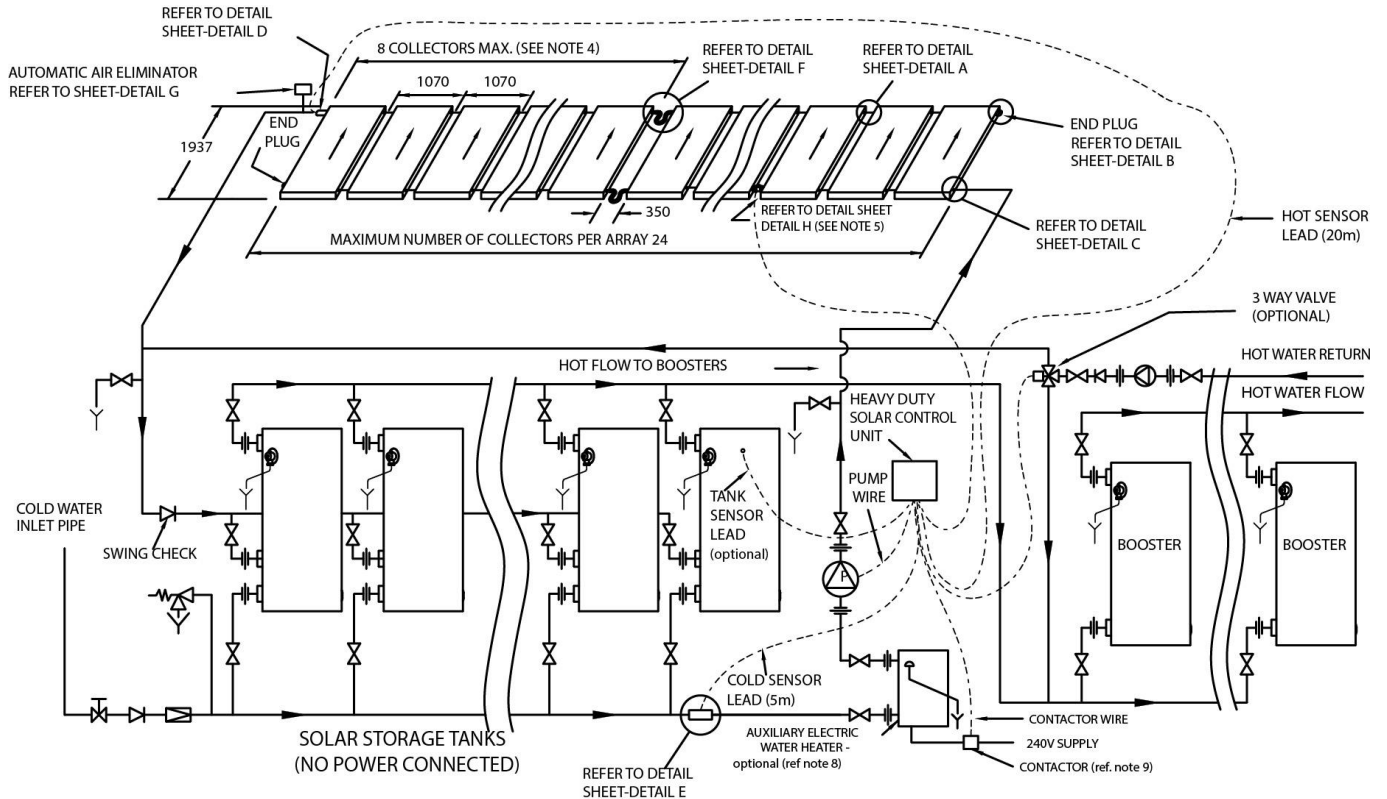

RHEEM COMMERCIAL SOLAR LOLINE DESIGN – SINGLE PANEL ARRAY

INSTALLATION – SYSTEM

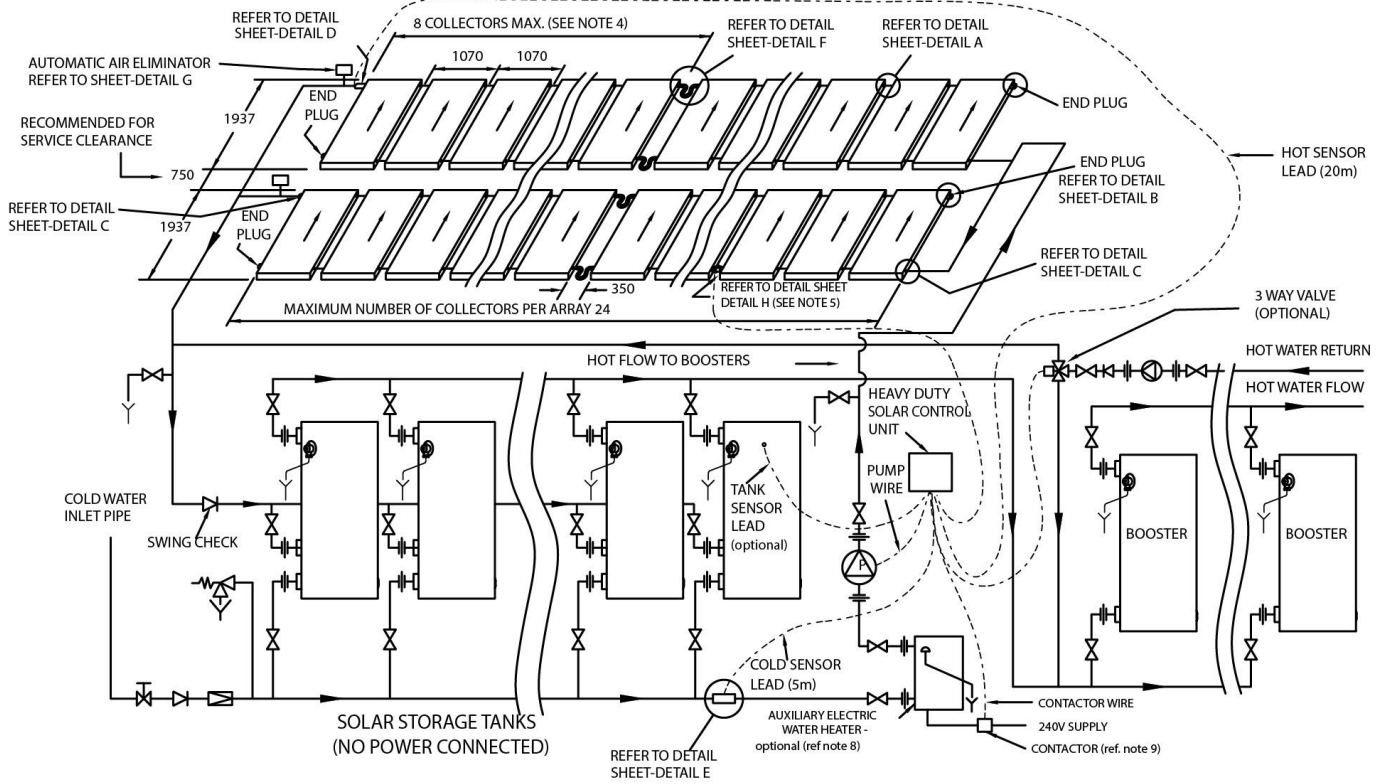

RHEEM COMMERCIAL SOLAR LOLINE DESIGN – DOUBLE PANEL ARRAY

INSTALLATION - STORAGE TANKS

IMPORTANT PLUMBING DETAILS

⚠ **Warning:** Certain types of plastic pipe, such as Polybutylene pipe, are not suitable to be used as a hot water pipe between:

- this water heater and a temperature limiting device, and
- this water heater and a hot water outlet if a temperature limiting device is not installed.

This water heater can produce water at a temperature and pressure which can exceed the performance limits of these types of pipe. This may result in pipe failure leading to severe water damage to the property. If one of these types of plastic pipe is used as a hot water pipe in the property, then a temperature limiting device must be installed between the water heater and this pipe work.

MAINS WATER SUPPLY

Where the mains water supply exceeds that shown in the table below, an approved pressure limiting valve is required and should be fitted as shown in the installation diagram (refer to diagram on page 29 and 30).

Model	340, 430	1000L SS
Relief valve setting	1000 kPa	700 kPa
Expansion control valve setting *	850 kPa	550 kPa
Max. mains supply pressure		
With expansion control valve	680 kPa	450 kPa
Without expansion control valve	800 kPa	550 kPa
Min. mains supply pressure	200 kPa	200 kPa

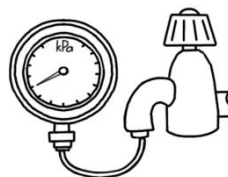

* Expansion control valve not supplied with the water heater.

TANK WATER SUPPLY

If the water heater is supplied with water from a tank supply and a minimum water supply pressure of 200 kPa at the water heater cannot be achieved, then a pressure pump system must be installed to allow the solar circuit system to operate. Care must be taken to avoid air locks. The cold water line from the supply tank should be adequately sized and fitted with a full flow gate valve or ball valve.

INSTALLATION - STORAGE TANKS

COLD WATER SUPPLY

An isolation valve and non return valve must be installed on the cold water line to the solar storage tanks. An acceptable arrangement is shown in the diagram on page 47

Expansion Control Valve

Local regulations may make it mandatory to install an expansion control valve (ECV) in the cold water line to the water heater. In other areas, an ECV is not required unless the saturation index is greater than +0.4 (refer to “Water Supplies” on page 15).

The expansion control valve must always be installed after the non return valve and be the last valve installed prior to the water heater (refer to diagrams on page 68). A copper drain line must be run separately from the drain of the relief valve.

The valve must be insulated with closed cell polymer insulation or similar (minimum thickness 9 mm) and the insulation installed so as not to impede the operation of the valve. The insulation must be weatherproof and UV resistant if exposed.

HOT WATER DELIVERY

This water heater can deliver water at temperatures which can cause scalding.

It is necessary and we recommend that a temperature limiting device be fitted between the water heater and the hot water outlets in any ablution area such as a bathroom, ensuite or public area, to reduce the risk of scalding. The installing plumber may have a legal obligation to ensure the installation of this water heater meets the delivery water temperature requirements of AS/NZS 3500.4 so that scalding water temperatures are not delivered to a bathroom, ensuite or other ablution and public areas.

The temperature limiting device used with a solar water heater should have a specified minimum temperature differential, i.e. between the hot water inlet and the tempered water outlet, of no greater than 10°C.

Temperature Limiting Device

⚠ Warning: A swing type non return valve **MUST BE** installed on the cold water line to the solar storage tank(s) **AFTER** the cold water branch to a temperature limiting device due to the higher temperature water generated under certain conditions in the solar collectors of this solar water heater. A swing type no-return valve certified for hot water use to AS1628 is recommended.

INSTALLATION - STORAGE TANKS

The cold water line to the temperature limiting device can be branched off the cold water line either before or after the isolation valve and pressure limiting valve to the solar storage tank, but it **MUST BE** before the non return valve. If an expansion control valve is required, it must always be installed after the non return valve and be the last valve prior to the solar storage tank.

If a combination isolation valve and non return valve (duo or trio valve) is installed on the cold water line to the solar water heater and the cold water line to the temperature limiting device branches off after this valve, then a second non return valve must be installed between the cold water branch and the solar storage tank.

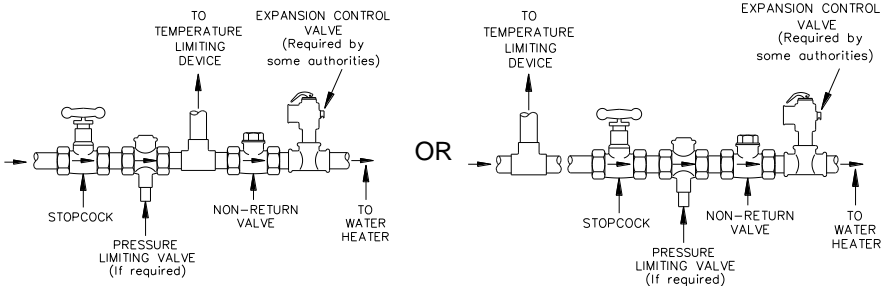

If a pressure limiting valve is installed on the cold water line to the solar water heater and the cold water line to a temperature limiting device branches off before this valve or from another cold water line in the premises, then a pressure limiting valve of an equal pressure setting may be required prior to the temperature limiting device.

Note: If this installation is a solar conversion of an existing water heating system and the cold water line to a temperature limiting device branches off the cold water line after the non return valve to the existing water heater, then the cold water branch **MUST BE** relocated to before the solar storage tanks and the solar preheat system non return valve.

CIRCULATED HOT WATER FLOW AND RETURN SYSTEM

The Rheem Commercial Solar Loline system can be installed as part of a circulated hot water flow and return system in a building if installed as shown in the [diagrams on pages 29 and 30](#). The booster must always be set to at least 60°C.

Circulated hot water and temperature limiting device

A temperature limiting device cannot be installed in circulated hot water flow and return pipe work unless it is specifically designed to do so, such as the Rheem Guardian warm water system.

INSTALLATION - STORAGE TANKS

The tempered water from a temperature limiting device cannot be circulated. Where a circulated hot water flow and return system is required in a building, a temperature limiting device can only be installed on a dead leg, branching off the circulated hot water flow and return pipe.

If circulated tempered water were to be returned back to the water heater, depending on the location of the return line connection on the water supply line to the water heater or storage tank, then either:

- water will be supplied to the cold water inlet of the temperature limiting device at a temperature exceeding the maximum recommended water supply temperature, or
- when the hot taps are closed no water will be supplied to the cold water inlet of the temperature limiting device whilst hot water will continue to be supplied to the hot water inlet of the temperature limiting device.

These conditions may result in either water at a temperature exceeding the requirements of AS/NZS 3500.4 being delivered to the hot water outlets in the ablution areas, or the device closing completely and not delivering water at all, or the device failing. Under either condition, the operation and performance of the device cannot be guaranteed.

REDUCING HEAT LOSSES

The cold water line to and the hot water line from the water heater must be insulated in accordance with the requirements of AS/NZS 3500.4. The insulation must be weatherproof and UV resistant if exposed.

The full length of the solar hot and solar cold pipes between the solar storage tank and the solar collectors **MUST BE** insulated. Refer to “**Warning: Plumber Be Aware**” on page 2.

Keep temperature settings down. Lower temperatures reduce heat losses and prolong cylinder life. Do not set the controlling thermostats on the booster water heater(s) above 70°C unless it is necessary.

INSTALLATION - STORAGE TANKS

SOLAR STORAGE TANK LOCATION

The solar storage tanks are suitable for either outdoor or indoor installation. They are to be installed at ground or floor level and must stand vertically upright on a stable base as acceptable to local authorities. Remember all local authorities have regulations about putting water heaters into roof spaces.

The solar storage tanks should be installed as close as possible to the solar collectors and their position chosen with safety and service in mind.

Consideration must also be given to the position of the booster water heaters in relation to the solar storage tanks.

Clearance must be allowed for servicing of the storage tanks. The storage tanks must be accessible without the use of a ladder or scaffold. Make sure the temperature pressure relief valve lever is accessible for service.

You must be able to read the information on the rating plate. If possible leave headroom of one water heater length so the anode can be inspected or replaced. Remember you may have to take the entire solar storage tank out later for servicing.

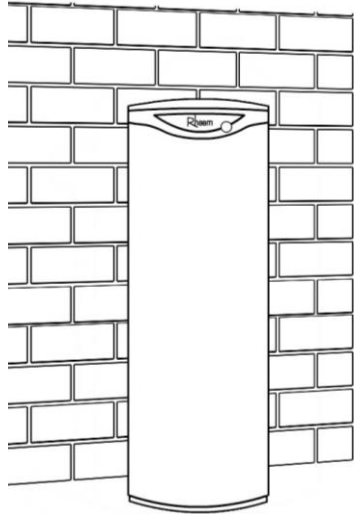

SAFE TRAY

Where damage to property can occur in the event of the water heater leaking, the solar storage tank must be installed in a safe tray or within suitably drained bunding. Construction, installation and draining of a safe tray must comply with AS/NZS 3500.4 and all local codes and regulatory authority requirements.

ANODE TYPES

The vitreous enamel lined cylinder of the water heater is only covered by the Rheem warranty when the total dissolved solids (TDS) content in the water is less than 2500 mg/L and when the correct colour coded anode is used. If an incorrect colour coded anode is used in the water heater, any resultant faults will not be covered by the Rheem warranty. In addition, the use of an incorrect colour coded anode may shorten the life of the water heater cylinder.

INSTALLATION - STORAGE TANKS

The correct anode type for the water supply being used must be fitted in vitreous enamel solar storage tanks (refer to "Water Supplies" on page 15). The black anode is fitted as standard.

Total Dissolved Solids in water supply to the water heater	Anode colour code
0 – 40 mg/L	Green
40 – 600 mg/L	Black
600 – 2500 mg/L	Blue

SADDLING - PIPE WORK

To prevent damage to the cylinder when attaching pipe clips or saddles to the solar storage tank jacket, we recommend the use of self-drilling screws with a maximum length of 13 mm. Should pre drilling be required, extreme caution must be observed when penetrating the jacket of the water heater.

Note: If the cylinder is damaged as a result of attaching pipe clips or saddles to the jacket, any resultant faults will not be covered by the Rheem warranty.

INSTALLATION - STORAGE TANKS

DIMENSIONS AND TECHNICAL DATA

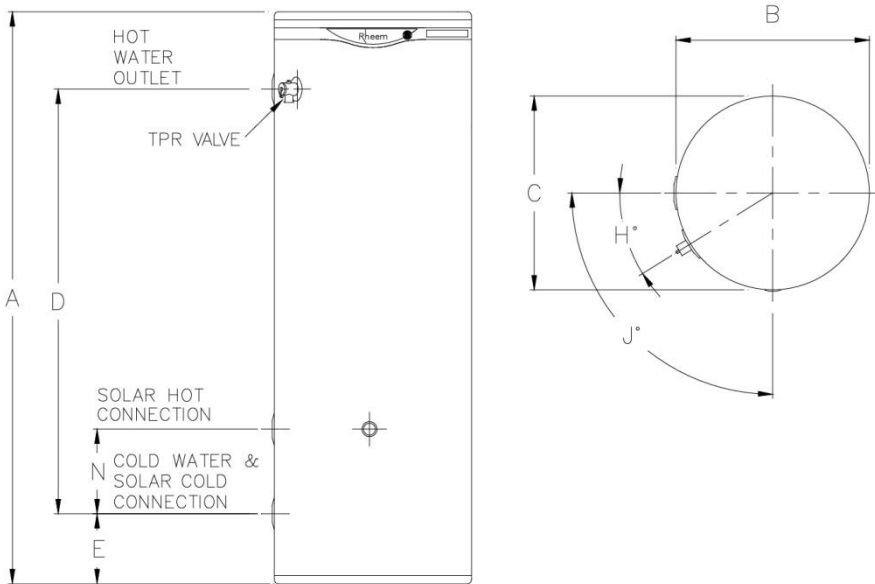

Solar storage tank mass (kg)			
Model	Capacity	Empty	Full
340	325 litre	96	412
430	410 litre	117	521
1000 SS	1037 litre	182	1219

Dimensions (mm)	A	B	C	D	E	H	J	N
610 340	1640	640	640	1298	115	32°	90°	290
610 430	1840	685	685	1482	108	30°	84°	273
1000 SS	2440	880	880	1780	350	180°	180°	300

CONNECTION SIZES

	610 340, 430	1000SS
• Hot water connection:	Rp 2	Rp 2
• Cold water connection:	Rp 2	Rp 2
• Solar hot (from collector) connection:	Rp 2	Rp 2
• Relief valve connection:	Rp 3/4	Rp 1

INSTALLATION - STORAGE TANKS

WATER INLET AND OUTLET

All pipe work must be cleared of foreign matter before connection and purged before attempting to operate the water heater. All olive compression fittings must use brass or copper olives. Use thread sealing tape or approved thread sealant on all fittings.

A disconnection union must always be provided at the cold water inlet, solar hot water inlet and hot water outlet on the solar storage tank to allow for disconnection of the solar storage tank.

Each solar storage tank has either a plastic dip tube or fitting liner in the inlet and outlet fittings (see diagram). These must be in place for the solar storage tanks to function properly. Do not remove or damage them by using heat nearby. They will be pushed into the correct position as the fitting is screwed in.

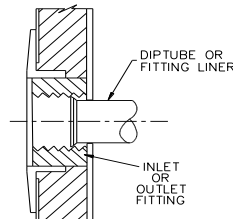

PIPE SIZES

The pipe sizing for hot water supply systems should be carried out by persons competent to do so, choosing the most suitable pipe size for each individual application.

The pipe work between the storage tank and collectors must be sized to achieve the correct flow rates. The length and diameter of the pipe work and the pump selection are interrelated. Refer to “[Solar Collector Location](#)” on page 36 and to “[the pipe size and pump selection table](#)” on page 42

Notes:

- It is important not to cross connect the solar cold and solar hot pipes to the incorrect connections.
- The solar cold pipe connects to the bottom of the solar collectors and the solar hot pipe connects to the top of the solar collectors diagonally opposite to the solar cold pipe connection.
- The hot sensor connection is at the solar hot outlet where the solar hot pipe connects to the solar collector.
- Refer to “[Warning: Plumber – Be Aware](#)” on page 2.

INSTALLATION - STORAGE TANKS

USING THE PIPE SIZE AND PUMP SELECTION TABLE

- Read off the total number of collectors in the far left column. If the actual number of collectors exceeds that shown, go to the next higher number.
- For each total number of collectors, the estimated typical amount of pipe work associated with the plumbing storage tanks and collectors is pre-determined. Determine the collector arrangement that best suits the installation, Parallel Arrangement (+) ie collector arrays are positioned **behind** one another or Side by Side Arrangement (++) ie collector arrays are positioned **beside** one another, and use this row when selecting appropriate pipe size, pump model and speed setting, see diagram on page 35.
- Determine the total flow **and** return pipe work between the last storage tank and the first collector and read this across the top of the table. If the actual number exceeds that shown, go to the next higher number.

Read across and down the table to determine the most appropriate pipe size, pump model and speed setting, eg DN25/32-80/3

Notes: Pipe size is shown as DN eg DN25. Pump model refers to Grundfos UP/S range, eg 32-80 = UPS32-80N. Pump speed is shown for UPS pumps. UP pumps are single speed.

- Example: 40 collectors installed in a parallel arrangement (+), with 25m between the last storage tank and the first collector.
 1. Use 45 collectors as this is the nearest, next highest to 40 collectors
 2. Use the row showing 63+ (63 represents the estimated total pipe work used to manifold the storage tanks and collectors, with the collectors in a parallel array configuration)
 3. Total length of flow **and** return = $25 \times 2 = 50\text{m}$
 4. Read across and down the table based on the chosen criteria
 5. Two options are available:
 - a. DN25/32-80/3 = DN25 copper pipe, Grundfos UPS32-80N pump set on speed 3
 - b. DN32/20-45 = DN32 copper pipe, Grundfos UP20-45N single speed pump.

Either option would be acceptable.

INSTALLATION - STORAGE TANKS

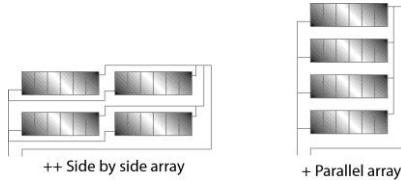

WARNING: Plumber – Be Aware

- The solar hot and solar cold pipe work between the solar storage tank and the solar collectors and between the solar storage tank and in-series booster (if one is installed) **MUST BE** of copper. All compression fittings must use brass or copper olives.

There must be a continuous fall from the solar collectors to the solar storage tank. Horizontal runs of pipe work are acceptable and may be installed.

Care must be taken if other than bendable grade or hard drawn tube is used to ensure the pipe work maintains a continuous fall or horizontal runs over the life of the installation. Pipe work should be fixed at regular intervals to assist in maintaining this requirement.

- Plastic pipe **MUST NOT** be used, as it will not withstand the temperature and pressure of the water generated by the solar collectors under stagnation conditions (150°C and 1000kPa). Failure of plastic pipe can lead to the release of high temperature water and cause severe water damage and flooding. (refer to [Warning on page 2](#)).

The full length of the solar hot and solar cold pipes **MUST BE** insulated. The insulation must:

- be of a closed cell type or equivalent, suitable for a solar water heating application and capable of withstanding the temperature of the water generated by the solar collectors under stagnation conditions
- be at least 13 mm thick, however thicker insulation may be required to comply with the requirements of AS/NZS 3500.4
- be weatherproof and UV resistant if exposed
- extend through any penetrations in the eaves, ceiling and roof
- cover valves and fittings in the solar hot and solar cold pipe work
- be fitted up to and cover the connections on both the solar storage tank and the solar collectors.

INSTALLATION - STORAGE TANKS

Note: Failure of these requirements to be observed increases the risk of freeze damage.

Uninsulated pipe work, including concealed in cavities and roof spaces or where it may be in contact with a metal roof, may lead to freeze damage. There is NO WARRANTY for freeze damage if the solar hot and solar cold pipes are not insulated in accordance with the installation instructions.

The insulation is essential to assist in providing freeze protection, will offer corrosion protection to a metal roof against water runoff over the copper pipe, assist in avoiding accidental contact with the solar pipe work as high temperature water can flow from the solar collectors to the solar storage tank and also reduce pipe heat losses.

The insulated pipe work:

- should be fixed at suitable locations to prevent or reduce the possibility of noise from water hammer and vibration from occurring
- is not to be placed or installed in contact with plastic pipe work.

The highest point of the solar cold pipe and solar hot pipe should be where they connect to the solar collectors, to avoid the possibility of air locks occurring in the system. Where this is not possible, automatic air eliminators should be installed at the highest points.

The pressure applied to the solar circuit and solar collectors during a pressure test of a direct open circuit system **MUST NOT** exceed 1000kPa, otherwise damage may result to the solar collectors. Refer to “[Pressure Testing on pg 71](#)”

INSTALLATION - STORAGE TANKS

Commercial Solar Pipe Size / Pump Selection / Speed Setting													
Total Number Collectors	Combined Tank & Array Piping Length (m)*	Total Length (flow and return) Between Storage Tanks and Collector Array (m)**											
		10	20	30	40	50	60	70	80	90	100	150	200
15	30	DN20/20-60/1		DN20/20-60/2						DN20/20-60/3		DN20/32-80/2	DN20/32-80/3
		DN25/20-60/1										DN25/20-60/2	
30	53+	DN25/20-45						-	-	-	-	-	
		DN25/20-60/2		DN25/20-60/3						DN25/32-80/2		DN32/20-60/2	
	53++	DN25/20-45						-	-	-	-	-	
		DN25/20-60/2		DN25/20-60/3						DN25/32-80/2		DN32/20-60/2	
45	63+	DN25/32-80/3				-	-	-	-	-	-	-	
		DN32/20-45						DN32/20-60/3		DN32/20-60/3			
	90++	DN32/20-45						DN32/20-60/3				DN32/32-80/3	
60	79+	DN32/32-80/3						-		-	-		
		DN40/20-45						DN40/20-60/3		DN40/32-80/3			
	120++	-	DN32/32-80/3				-	-	-	-	-	-	
DN40/20-45						DN40/20-60/3		DN40/32-80/3					

INSTALLATION - STORAGE TANKS

Commercial Solar Pipe Size / Pump Selection / Speed Setting								
Total Number Collectors	Combined Tank & Array Piping Length (m)*	Total Length (flow and return) Between Storage Tanks and Collector Array (m)**						
		10	20	30	40	50 to 100	150	200
75	92+	-	-	DN40/20-60/3	DN40/32-80/3			
				DN50/20-45				
	111++	-	-	DN40/32-80/3				
				DN50/20-45				
90	105+	-	-	DN40/32-80/3		-	-	
				DN50/20-60/3		DN50/32-80/2	DN50/32-80/2	
	159++	-	-	DN40/32-80/3	-		-	-
				DN50/20-60/3		DN50/32-80/2	DN50/32-80/3	
105	118+	-	-	-	DN50/32-80/3			
	160++	-	-	-	DN50/32-80/3			
120	131+	-	-	-	DN50/32-80/3			
	215++	-	-	-	DN50/32-80/3			

INSTALLATION - STORAGE TANKS

RELIEF VALVE

The TPR valve is shipped in a bag at the base of the storage tank. The TPR valve(s) must be fitted before the water heater is operated. Before fitting the TPR(s), make sure the probe has not been bent. Seal the thread with Teflon tape - never hemp. Make sure the tape does not hang over the end of the thread.

Screw the valve(s) into the correct opening (refer to the **label on the storage tank**) leaving the valve outlet pointing downwards. Do not use a wrench on the valve body - use the spanner flats provided.

RELIEF VALVE DRAIN

A copper drain line must be fitted to the relief valve to carry the discharge clear of the storage tanks. Connect the drain line to the relief valve using a disconnection union. The pipe work from the relief valve to the drain should be as short as possible and fall all the way from the water heater with no restrictions. It should have no more than three right angle bends in it. Use DN20 pipe for a ¾" relief valve and DN25 pipe for a 1" relief valve.

The outlet of the drain line must be in such a position that flow out of the pipe can be easily seen (refer to AS/NZS 3500.4) - but arranged so hot water discharge will not cause injury, damage or nuisance. The drain line must discharge at an outlet or air break not more than 9 metres from the relief valve.

In locations where water pipes are prone to freezing, the drain line must be insulated and not exceed 300 mm in length. In this instance, the drain line is to discharge into a tundish through an air gap of between 75 mm and 150 mm.

For multiple installations the drain line from each storage tank can discharge into a common tundish (refer to **"Multiple Installations"** on pages 46 and 47).

⚠ Warning: As the function of the temperature pressure relief valve on the storage tank is to discharge high temperature water under certain conditions, it is strongly recommended the pipe work downstream of the relief valve be capable of carrying water exceeding 93°C. Failure to observe this precaution may result in damage to pipe work and property.

MULTIPLE INSTALLATIONS

A multiple installation of solar storage tanks on a single manifold or multiple manifolds is possible, using the Equa-Flow[®] manifold system, where large volumes of hot water is required. The Equa-Flow principle will function with solar storage tanks in line, around a corner or in rows back to back (refer to the diagrams on page 46).

The cold water and hot water manifolds must be designed to balance the flow from each solar storage tank. To achieve this, there are basic installation requirements and principles which must be followed:

1. The number of solar storage tanks in a bank (with 50mm fittings) should be no more than 10, however several banks of solar storage tanks can be installed.
2. The hot water line from the manifold must leave from the opposite end to which the cold water line enters the manifold.
3. The solar storage tanks must be of the same model.
4. The cold water line, cold and hot water headers and hot water line must be sized to meet the requirements of both AS/NZS 3500.4 and the application.
5. A non return valve, isolation valve and if required a pressure limiting valve and expansion control valve, must be installed on the cold water line to the system.
6. A full flow gate valve or ball valve (not a stop tap, as used on a single solar storage tank installation) must be installed on the cold water branch, solar flow branch and hot water branch of each solar storage tank.
7. Non return valves or pressure limiting valves **must not** be installed on the branch lines to the solar storage tanks.
8. All fittings, valves and branch lines must be matched sets all the way along the manifold.
9. Sufficient space must be left to enable access, servicing or removal of any solar storage tank.
10. The temperature pressure relief valve drain line from each solar storage tank can terminate at a common tundish (funnel) with a visible air break at each drain discharge point (refer to the diagram on page 46 and to "Relief Drain Line" on page 44).

Refer to the diagrams on pages 46 to 49 for installation and plant layout details.

MULTIPLE INSTALLATIONS

In Line Manifold

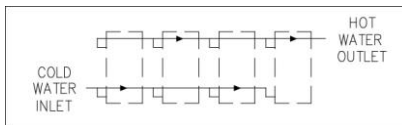
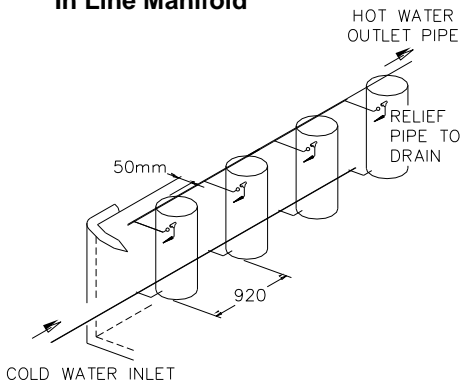

Single Bank of Water Heaters

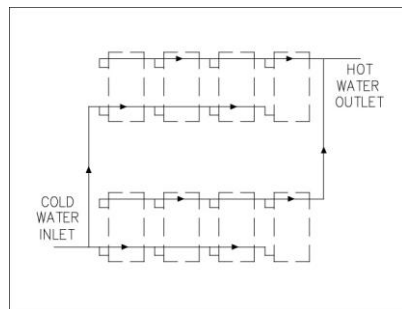

Multiple Banks of Water Heaters

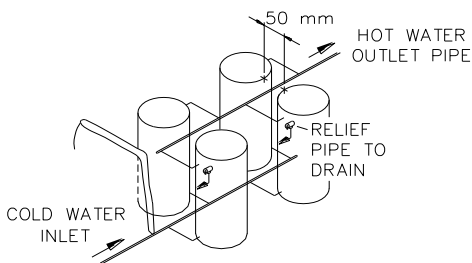
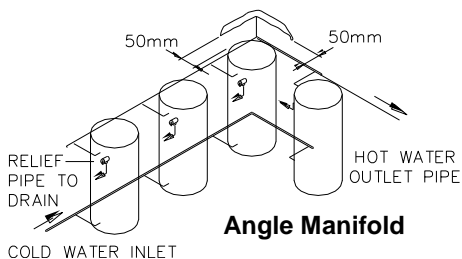















FIX ALL PIPES SECURELY
IN POSITION CENTRALLY
OVER TUNDISH



TO FINAL DISCHARGE IN
ACCORDANCE WITH THE
REQUIREMENTS OF AS/NZS
3500.4

MULTIPLE INSTALLATIONS

LEGEND

-  STOP VALVE
-  NON RETURN VALVE
-  PRESSURE LIMITING VALVE
-  EXPANSION CONTROL VALVE
-  GATE VALVE
-  CIRCULATOR
-  UNION
-  TUNDISH
-  DIRECTION OF FLOW
-  COLD WATER SUPPLY
-  PRIMARY FLOW & RETURN
-  HOT WATER FLOW & RETURN
-  COLD SENSOR CONNECTOR
-  COMMERCIAL SOLAR CONTROL UNIT

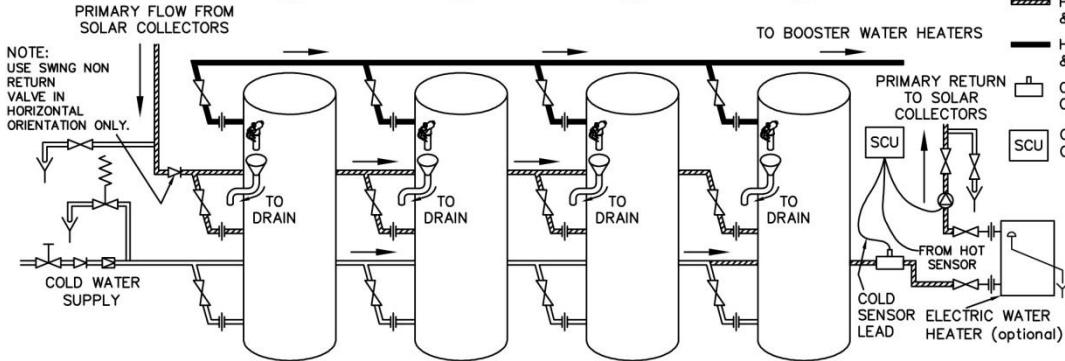
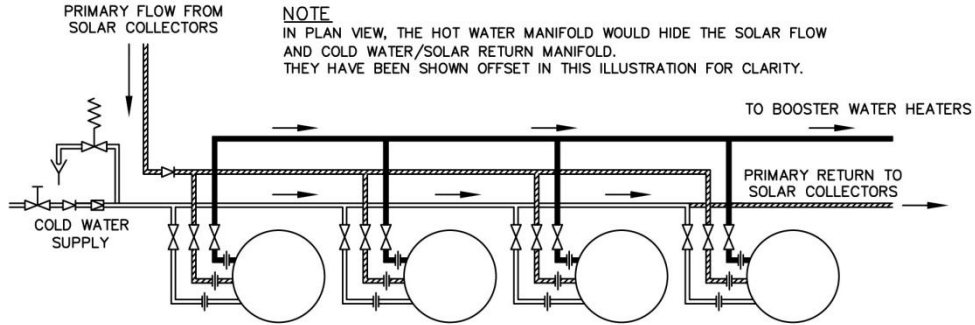

Typical Installation – Rheem Commercial Solar Loline Storage Tanks

MULTIPLE INSTALLATIONS

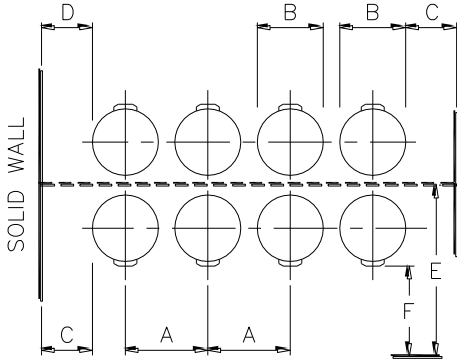
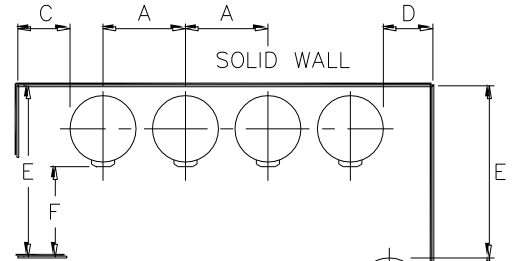
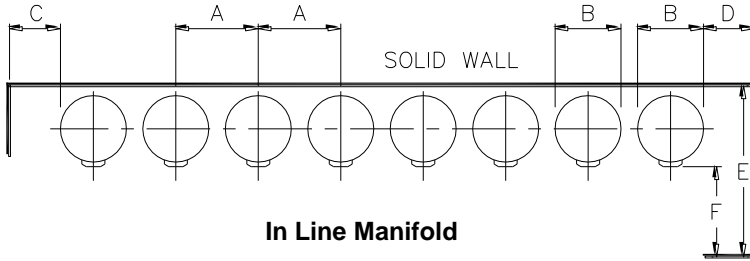

NOTES:
 Minimum recommended space between wall and back of water heater is 100 mm.
 A minimum of 900 mm (E* & F*) should be left in front of the water heater for access, servicing and water heater removal.

Installation Layout Minimum Dimensions						
Model	A	B	C	D	E*	F*
340	900	640	300	100	1640	900
430	940	690	300	100	1690	900
1000SS	1140	880	300	100	2080	1100

INSTALLATION DIMENSIONS –COMMERCIAL SOLAR LOLINE STORAGE TANKS

MULTIPLE INSTALLATIONS

MANIFOLD ARRANGEMENT

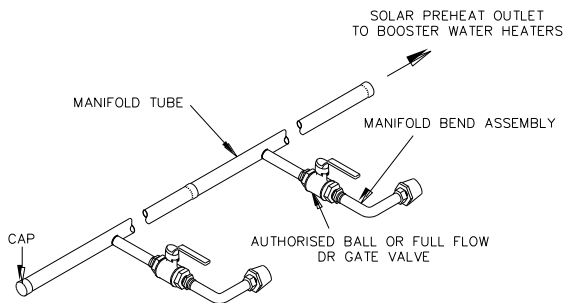

Hot Manifold Assembly

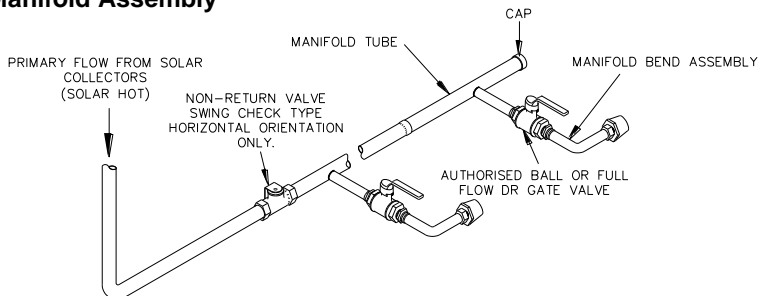

Solar Hot Manifold Assembly

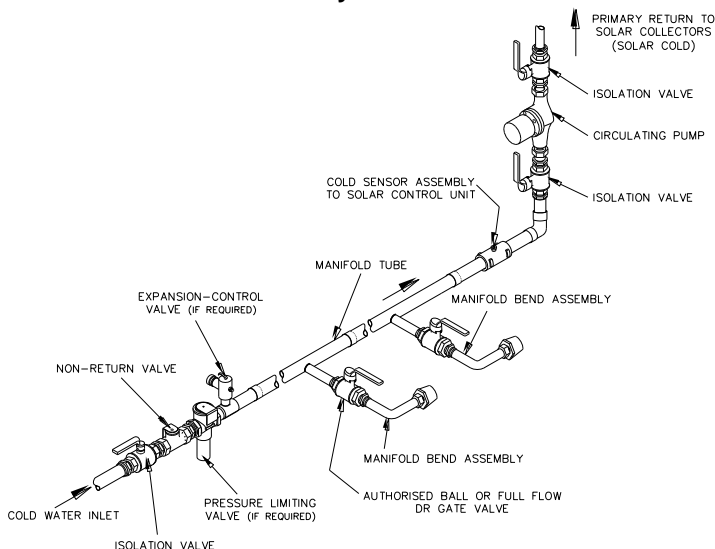

Cold Water and Solar Cold Manifold Assembly

INSTALLATION – SOLAR COLD AND SOLAR HOT MANIFOLDS

COLD WATER AND SOLAR COLD MANIFOLD

- Install the cold sensor connector in the solar cold pipe, between the last solar storage tank and the solar circulator utilising two union connections, one on either side of the sensor connector.

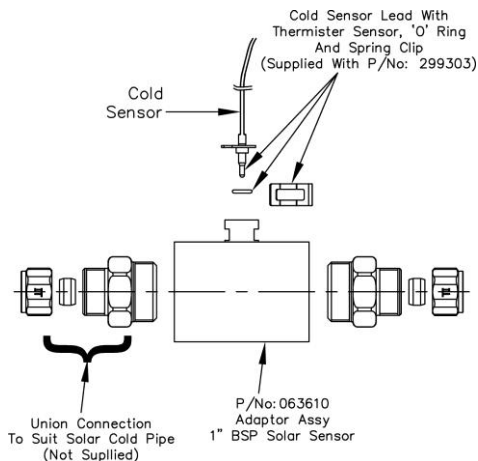

Cold Sensor Assembly

Auxiliary Electric Heater (optional)

- The auxiliary electric heater is designed to provide additional energy to the solar collectors during frost conditions should there be insufficient solar energy available in the storage tanks.
- In areas not subject to freeze conditions, the auxiliary electric heater is optional.
- If required, install the auxiliary electric heater in the solar cold pipe, after the cold sensor connector and before the solar circulator. A disconnection union and full flow isolation valve must be installed on the inlet and outlet of the auxiliary electric heater and circulator(s). Refer to diagrams on page 29 and 30.

Solar Circulator

- Install the solar circulator(s) in the solar cold pipe after the cold sensor connector or after the auxiliary electric heater, if installed. Refer to the installation instructions supplied with the circulator.

INSTALLATION – SOLAR COLD AND SOLAR HOT MANIFOLDS

- Note: Circulators are water cooled and MUST be installed with the shaft spindle horizontal.

A disconnection union and full flow isolation valve must be installed on the inlet and outlet of the auxiliary electric heater and circulator(s). It is not necessary to install a non return valve after the circulator.

Solar Cold Pipe Drain Line

- Install a drain line with a full flow isolation valve to the solar cold pipe after the solar circulator and its isolation valve. Refer to the diagram on page 47.

Ensure the drain valve outlet is pointing downwards away from any controls.

- Connect a copper drain line to the drain valve, using a disconnection union, to carry the discharge clear of the solar storage tanks and solar controls.
- The drain line should be as short as possible and fall all the way from the valve with no restrictions. It should have no more than three right angle bends in it.
- The outlet of the drain line must be in such a position that flow out of the pipe can be easily seen (refer to AS/NZS 3500.4) - but arranged so water discharge will not cause injury, damage, nuisance or splashing. The water discharged may be of a high temperature under certain conditions.

Solar Cold Pipe

- Continue the solar cold pipe to the inlet of the solar collector array.

SOLAR HOT MANIFOLD

Run the solar hot pipe from the outlet of the solar collector array to the solar storage tanks.

Solar Hot Pipe Drain Line

- Install a drain line with full flow isolation valve to the solar hot pipe just prior to the non return valve (between solar collectors and non return valve). Refer to the diagram on page 47.

Ensure the drain valve outlet is pointing downwards away from any controls.

- Connect a copper drain line to the drain valve, using a disconnection union, to carry the discharge clear of the storage tanks and solar controls.
- The drain line should be as short as possible and fall all the way from the valve with no restrictions. It should have no more than three right angle bends in it.

INSTALLATION – SOLAR COLD AND SOLAR HOT MANIFOLDS

- The outlet of the drain line must be in such a position that flow out of the pipe can be easily seen (refer to AS/NZS 3500.4) - but arranged so water discharge will not cause injury, damage, nuisance or splashing. The water discharged may be of a high temperature under certain conditions.

Non Return Valve

- Install a suitably sized swing type non return valve in the solar hot pipe.

The non return valve must be installed in a horizontal orientation in a position between the solar hot pipe drain line and solar storage tanks. The non return valve is required to prevent reverse flow through the solar hot pipe. Refer to the [diagram on page 47](#).

Solar Hot Pipe Completion

- Connect the solar hot pipe to the solar hot inlet of each solar storage tank. Refer to [diagrams on page 47](#).
- Insulate the solar cold and solar hot pipes, including the air bleed valve and non return valve assemblies, with a closed cell type or similar (minimum thickness 13 mm). The insulation must be weatherproof and UV resistant if exposed. Refer to “[Warning: Plumber – Be Aware](#)” on page 2.

Note: Use thread sealing tape or an approved thread sealant on all fittings.

INSTALLATION – SOLAR COLLECTORS

SOLAR COLLECTOR LOCATION

Consideration must be given to the position of the solar storage tanks in relation to the solar collectors. The solar hot and solar cold pipes between the solar storage tank and the solar collectors must be sized to achieve the correct flow rates and the circulator must be sized and selected with the length and diameter of the pipe work taken into consideration. Refer to “Solar Water Heater Storage Tank Location” on page 35 and to “Pipe size and pump selection chart” on page 42 and 43

- Solar collectors must be installed in a shade free position.
- The installation must comply with the requirements of AS/NZS 3500.4 and all local codes and regulatory authority requirements

ORIENTATION OF SOLAR COLLECTORS

For optimum performance solar collectors should be installed facing toward the equator (i.e. north facing in the southern hemisphere and south facing in the northern hemisphere). Where this orientation is not practical, a system facing up to 45° from the equator will receive about 4% less total solar radiation.

INCLINATION OF SOLAR COLLECTORS

For optimum performance inclination of the solar collectors should be approximately equal to 90% of the local latitude angle. The **latitudes of some Australian cities** are listed on page 54. Solar collectors may be installed at the roof angle on a pitched roof for simplicity of installation and appearance, but must never be flat. If the roof angle varies by 20° from the optimum angle, the solar collectors will receive about 10% less total solar radiation.

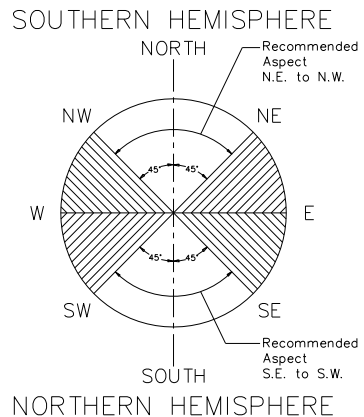

Although the solar collectors can be installed with an inclination of less than 10°, this is not advised.

The risks include:

- the collector glass not 'self cleaning', leading to dirty collector glass reducing solar performance,
- condensation on the underside of the glass taking longer to clear,

INSTALLATION – SOLAR COLLECTORS

- condensation droplets falling onto the absorber plate potentially causing discolouration.
- For an installation where the roof pitch is less than 10°, or varies by more than 20° from the optimum angle a Variable Pitch stand is recommended.
- For an installation at right angles to (across) the roof pitch, a Flat Roof stand and an Across Pitch kit are both required. Refer to your local Solar Distributor for details.
- For an installation opposite to (against) the roof pitch, a Flat Roof stand and an Against Pitch kit are both required. Refer to your local Solar Distributor for details.
- The collector straps and angles are suitable for installations on a pitched roof with an inclination of up to 30°. Where the solar collectors are installed at inclinations greater than 30°, a With Pitch frame is necessary. Refer to your local Solar Distributor for details.
- The installer must ensure the structural integrity of the building is not compromised by the installation of the solar water heater and the roof structure is suitable to carry the full weight of the solar collector(s). If in doubt the roof structure should be suitably strengthened. Consult a structural engineer.
- The roof area required for each solar collector is approximately 1.2 m wide x 2.0 m deep.
- The roof must be suitable to take the mass of the solar collectors. Each solar collector and its fittings weighs approximately 40 kg when full of water Allow an additional 43 kg per two collectors when Variable Pitch stands are used.

LATITUDE OF SOME AUSTRALIAN CITIES

Adelaide	35°S	Cairns	17°S	Hobart	42°S	Port Hedland	20°S
Alice Springs	24°S	Canberra	35°S	Mildura	34°S	Rockhampton	24°S
Brisbane	27°S	Darwin	12°S	Melbourne	38°S	Sydney	34°S
Broken Hill	31°S	Geraldton	28°S	Perth	32°S	Townsville	19°S

CYCLONIC OR HIGH WIND AREAS

For an installation of solar collectors on a **pitched roof** in a cyclonic or high wind area, a suitable With Pitch frame is required. The installation of these solar collectors on a With Pitch frame, subject to the frame's design criteria not

INSTALLATION – SOLAR COLLECTORS

being exceeded, is suitable for installation in geographic locations up to and within Wind Region D, as defined in the Building Code of Australia, and provides an acceptable method of installation where it is necessary to satisfy the requirements of the Building Code of Australia. For an installation of solar collectors on a **flat roof** in a cyclonic or high wind area, a suitable Variable Pitch frame is required. Variable Pitch frames are not suitable for use in Wind Region D. The suitability of the Variable Pitch frame in each wind region will depend on the terrain category, topographic class, wind speed, height and specific location of the installation on the roof.

The Variable Pitch frame with Rheem solar collectors, has a maximum pressure loading of 6085Pa or a maximum building height of 200m, neither of these must be exceeded.

It is the responsibility of the designer to determine the actual wind load acting on the solar frame and collector assembly for the installation site and satisfy themselves as to the suitability of the frame and collector assembly.

Fixing of frames to building members must be designed by a structural engineer to satisfy the design wind loads for the building.

ROOF ASSEMBLY OF SOLAR COLLECTORS

General Notes:

- Do not remove the solar collector packaging completely, prior to the installation. Remove only sufficient packaging material to enable the installation. Upon completion of the installation it is necessary to leave the solar collector packaging covering the glass and fittings on the solar collector. The packaging should not be removed until the solar collector is filled with water and ready for use, otherwise damage to the solar collector can occur.
- Connectors, sensor connectors, end plugs, 'O' rings, expansion tubes, copper or brass olives and compression nuts are required for each installation. Collector straps and collector angles are required if the installation is on a pitched roof. The components identified with a Rheem part number on the detail diagrams are available from Rheem. All other pipes and fittings shown shall be provided by the contractor.
- The maximum number of solar collectors in an array is 24 for NPT 200 collectors, with an expansion tube set required to be fitted at no more than every eighth solar collector. A gap of approximately 360mm must be allowed for in the appropriate section of the array to accommodate the expansion tube. Refer to point 5. Multiple arrays can be installed. Each array should have an equal number of solar collectors.
- All compression fittings must use brass or copper olives.

INSTALLATION – SOLAR COLLECTORS

- Suitable screws or anchors will be required to fix the collector straps and collector angles to the solar collectors and to the rafters for a pitched roof installation. Screws to secure the collector straps and collector angle to the solar collectors must be no longer than 15 mm.

DO NOT MODIFY THESE PARTS IN ANY WAY.

1. **Solar Collector Location:** Select a suitable position for the solar collectors.

Refer to “Solar Collector Location” on page 53.

2. **Collector Angle – Pitched Roof Installation:** Determine the location of the collector angle(s). Locate the collector angle(s) adjacent to each other.

Hook two collector straps to each collector angle.

Tile Roof: Remove the tiles on the next row above the position of the collector angle to expose the rafters. Ensure the collector angle is horizontal. Once in position, fix the collector straps to the rafters, using suitable screws or anchors. Replace the tiles.

Metal Roof: Ensure the collector angle is horizontal. Once in position, fix the collector straps to the rafters, through the metal roofing material, using suitable screws for anchors. Care should be taken not to mark Colorbond® or other metal roof sheet with a marking pen and to remove all swarf from the metal roof as these can cause deterioration of the metal roofing material.

Note: Fixings must penetrate only through the high point in the roof material profile.

Solar Stand – Flat Roof Installation: Determine the location of the Variable Pitch stand(s). Assemble and fix the stand(s) to the roof, following the installation instructions provided with the stand(s).

Solar Stand – Across Pitch or Against Pitch Installation: Determine the location of each Across Pitch kit and Flat Roof stand or each Against Pitch kit and Flat Roof stand. Assemble and fix the stands to the roof, following the instructions provided with the stands.

3. **Solar Collectors:** Position the solar collectors with the lower ends seated in the collector angle or rail.
4. **Collector Unions:** For multiple solar collectors, couple the solar collectors together using the collector unions and ‘O’ rings. Refer to diagram below.

INSTALLATION – SOLAR COLLECTORS

- **Note:** An expansion tube will be required in the array if more than 8 collectors in an array are to be installed. A gap of approximately 360mm must be allowed for in the appropriate section of the array to accommodate the expansion tube. Refer to point 5.
- Seat an 'O' ring into each of the collector connections to be joined.
- Fit a collector union to each collector connection of the first solar collector to receive the second solar collector and screw in the unions until they seat firmly against their 'O' ring, applying sufficient torque with a spanner to ensure a leak free joint.
- Place the collector unions into the collector connections on the second solar collector and screw in the unions until they seat firmly against the 'O' rings, applying sufficient torque with a spanner to ensure a leak free joint.

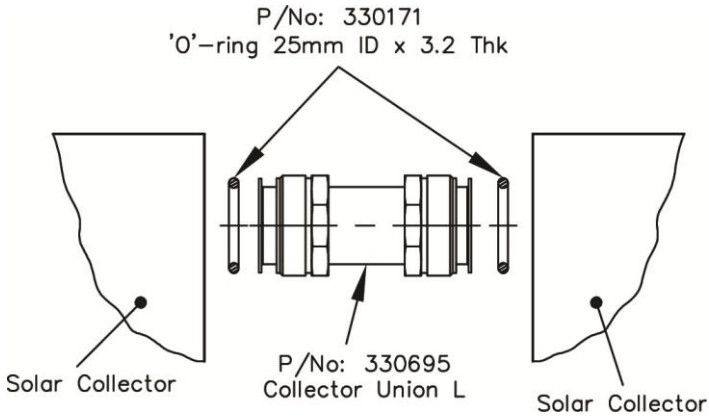

COLLECTOR UNION ASSEMBLY

INSTALLATION – SOLAR COLLECTORS

5. Expansion Tubes: For multiple NPT 200 solar collectors of more than 8 in a single array, install an expansion tube at the top and bottom of the array at no more than every eighth solar collector. Refer to diagram below.

- A gap of approximately 360mm must be maintained between the two collectors. The expansion tube may be stretched or compressed slightly to assist with fitment.
- Seat an 'O' ring into each of the collector connections to be joined.
- Fit the M33 adaptor fitting to each collector connection and screw in until it sits firmly against its 'O' ring, applying sufficient torque with a spanner to ensure a leak free joint.
- Fit the expansion tube to the M33 adaptor fitting and tighten loosely.
- Position the expansion tube so that it is essentially horizontal $\pm 0-15^\circ$. Positioning the tube above the horizontal may create an air pocket. Positioning the expansion tube more than 15° below the horizontal may create a heat trap and interfere with the normal operation of the collectors. Refer to diagram on page 59.
- Tighten compression nuts, using the spanner flats, applying sufficient torque with a spanner to ensure a leak free joint.

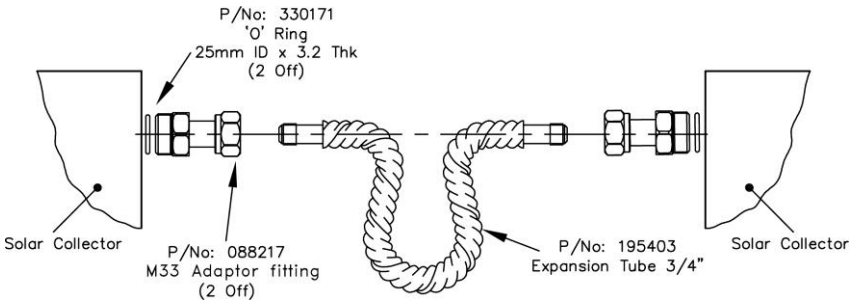

EXPANSION TUBE ASSEMBLY

INSTALLATION – SOLAR COLLECTORS

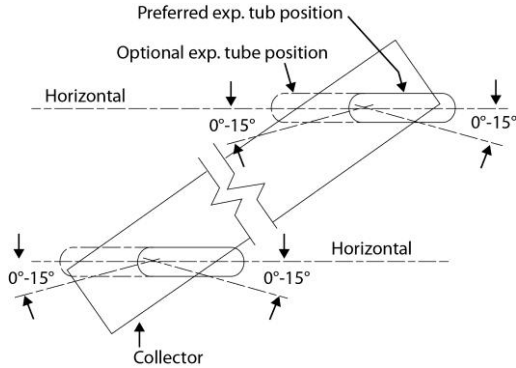

POSITION OF EXPANSION TUBE

6. **Frost Sensor:** The frost sensor housing will replace one of the collector unions. Fit the frost sensor housing at the bottom, as near as practical to the centre of an array. Refer to diagram below.

Note: The frost sensor **MUST** be fitted in all installations.

- Seat an 'O' ring into each of the collector connections to be joined.
- Fit the frost sensor housing to the first solar collector and screw in the union until it seats firmly against the 'O' ring, applying sufficient torque with a spanner to ensure a leak free joint.

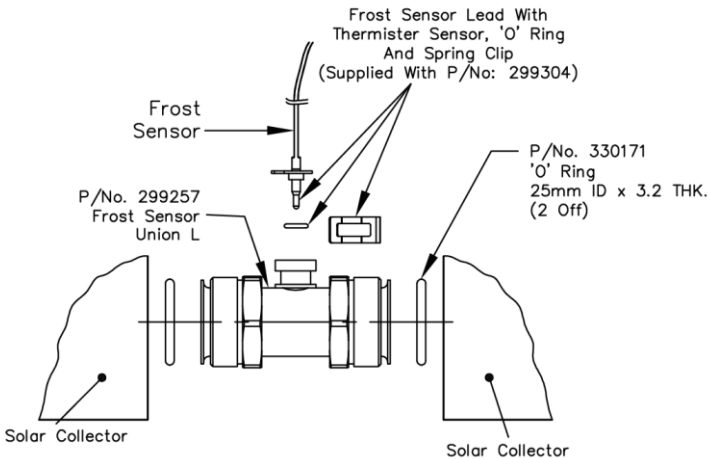

FROST SENSOR ASSEMBLY

INSTALLATION – SOLAR COLLECTORS

7. Fixing Collectors to Roof

Fixing collector pitched roof installation

Once all connections between collectors in an array are complete, the collectors are to be fixed in position.

Bottom – Ensure the solar collectors are well seated in the collector angle.
Screw the collector angle to the solar collectors (two screws per collector).

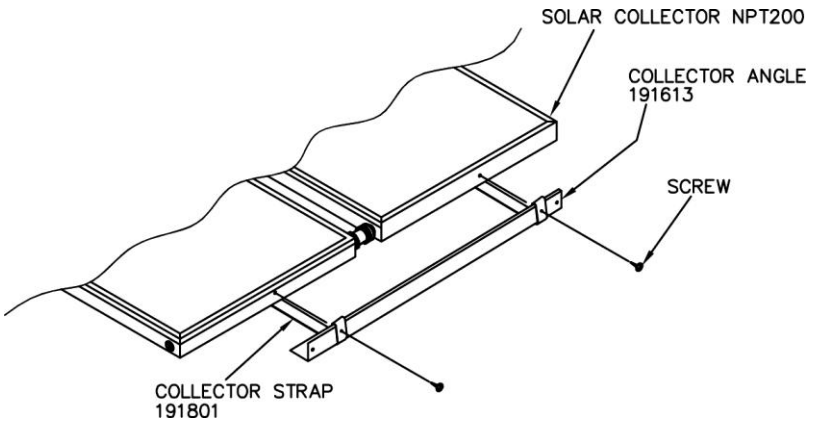

Top – Position a collector strap against the top end of each solar collector.

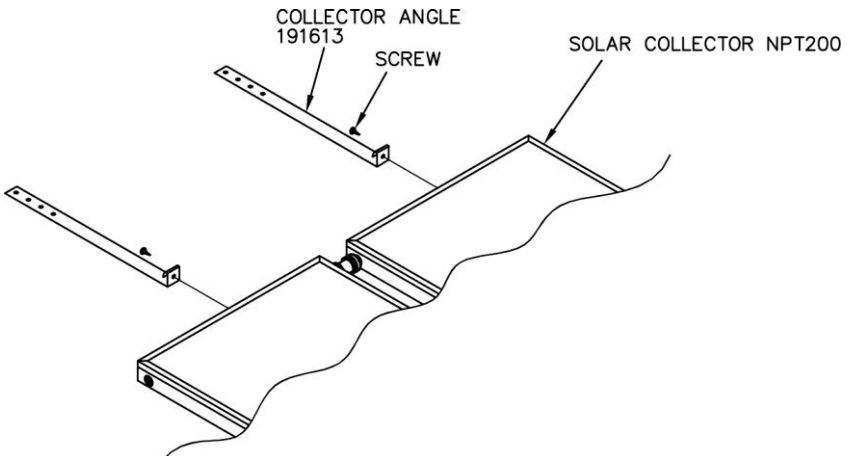

INSTALLATION – SOLAR COLLECTORS

Tile Roof: Remove the tiles on the next row above the top edge of the solar collectors to expose the rafters. Once in position, fix the collector straps to the rafters, using suitable screws or anchors. Replace the tiles.

Metal Roof: Once in position, fix the collector straps to the rafters, through the metal roofing material, using suitable screws or anchors. The collector straps may be cut to a length of approximately 100 mm to retain the aesthetics of the installation.

Note: Fixings must penetrate only through the high point in the roof material profile.

Screw the collector straps to the solar collectors. Screws must be no longer than 15 mm.

Fixing Collector Flat Roof, Across Pitch or Against Pitch Installation:

Once all connections **between** collectors in an array are complete, the collectors are to be fixed in position.

- **Solar Stand (bottom and top)** – Ensure the solar collectors are well seated in the collector angle. Clamp the solar collectors (four clamps per collector) to the collector rails, using the clamps, hex screws, washers and nuts provided with the Variable Pitch stand.

INSTALLATION – SOLAR COLLECTORS

- **Array Inlet Connector:** Fit an inlet/outlet connector to the inlet of each solar collector array using an 'O' ring. Refer to drawing below.
- Seat an 'O' ring into the collector connection.
- Place the connector into the collector connection and screw in the union until it seats firmly against the 'O' ring, applying sufficient torque with a spanner to ensure a leak free joint.
- Place the compression nut and olive over the end of the solar cold pipe. Position the cold pipe into the connector, seat the olive and tighten the compression nut.

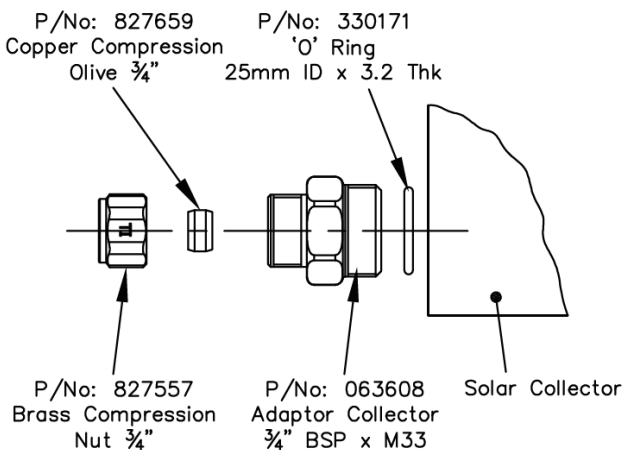

INLET/OUTLET CONNECTOR ASSEMBLY (WATER CONNECTION TO SOLAR COLLECTOR)

INSTALLATION – SOLAR COLLECTORS

8. **Sensor Connector:** Repeat Step 8 with the sensor connector (with hot sensor port) to the outlet of the solar collector array using an 'O' ring. Refer to drawing below.

Note: If more than one array of solar collectors is to be installed, then use an inlet/outlet connector on the outlet of all but the last array. Only one sensor connector is required for the hot sensor probe connection at the solar collectors.

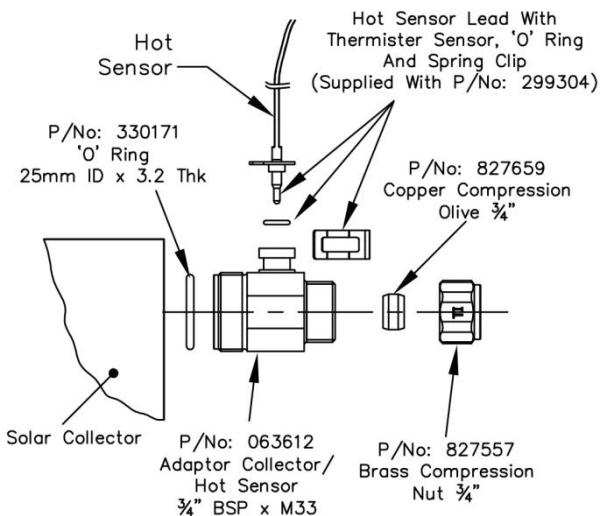

HOT SENSOR CONNECTOR ASSEMBLY

INSTALLATION – SOLAR COLLECTORS

9. **End Plugs:** Fit the end plugs to the two remaining solar collector connections on each array, using the 'O' rings and blanking discs provided. Refer to drawing below.
- Seat an 'O' ring into the collector connection.
 - Place a blanking disc over the seated 'O' ring.
 - Place the end plug into the collector connection and screw in until it seats firmly against the blanking disc, applying sufficient torque with a spanner to ensure a leak free joint.

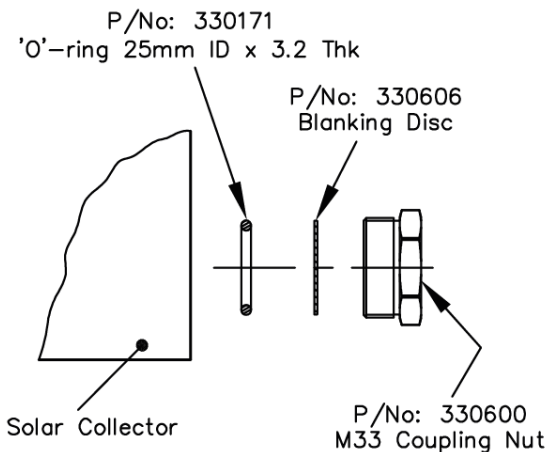

END PLUG ASSEMBLY

INSTALLATION – SOLAR COLLECTORS

10. Air Eliminator: An automatic air eliminator must be installed at the highest point in each collector array. This will be in the solar hot pipe at the outlet of the solar collectors. Refer to drawing below.

Note: If the solar collectors are installed on pitched roofs, only one automatic air eliminator is required to be installed at the highest point of all the arrays.

- Braze a short length of 3/4" copper pipe to one side of the Tee.
- Braze the solar hot pipe (or solar hot branch if more than one array) to the other side of the Tee. Ensure the Tee branch will be orientated vertically when assembled to the collector array.
- Fit the short length of copper into the compression fitting at the outlet of the array and tighten.
- Fit the 3/4" x 3/8" Bush to the Tee.
- Screw the automatic air eliminator into the Bush.

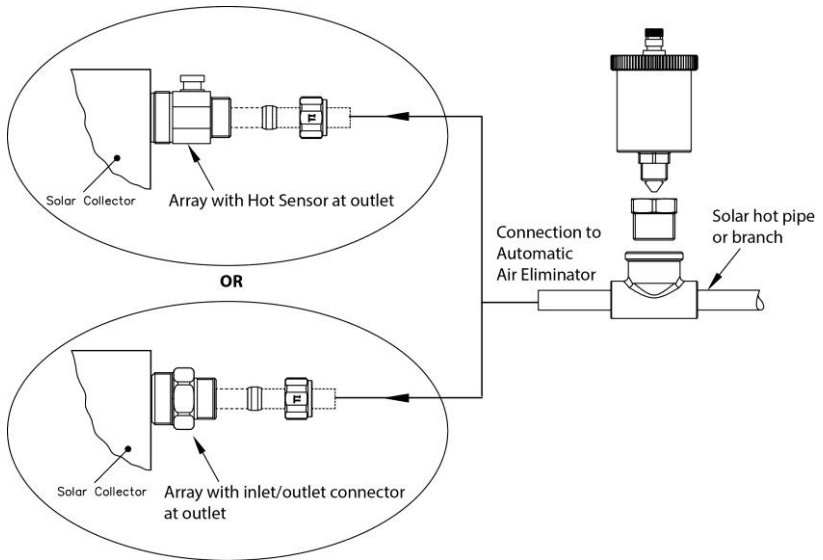

AUTOMATIC AIR ELIMINATOR

INSTALLATION – SOLAR COLLECTORS

SOLAR COLD AND SOLAR HOT PIPES

Connect the solar cold pipe to the connector at the inlet of the solar collectors using the compression nuts and olives.

Connect the solar hot pipe to the outlet of the solar collectors using the compression nuts and olives or to the automatic air eliminator Tee where applicable.

Refer to [installation diagrams on pages 29 and 30](#).

The solar hot and solar cold pipes should be sized to suit the installation.

⚠ Warning: Plumber – Be Aware: It is important you refer to [“Warning: Plumber – Be Aware”](#) on page 2 for important information relating to the installation of the solar hot and solar cold pipes.

Notes:

- Penetrations through the roofing material must be:
 - at the high point of the roof tile or metal sheet;
 - made neatly and kept as small as practicable;
 - waterproofed upon installation of the solar hot and solar cold pipes.
- Exposed insulated pipe work between the solar collectors and the penetrations through the roofing material should be kept to a minimum to maintain the aesthetics of the installation.

SOLAR CONTROL UNIT

The solar control unit is designed to be mounted on a wall adjacent to the solar storage tanks or on the side of a solar storage tank. The solar control unit, supplied with a 1.8 metre power cord, requires a 240 V 50 Hz general purpose outlet (GPO) located within 1.2 metres of its location. The GPO must have a continuous power supply. The GPO is required to be weatherproof if installed outdoors. Refer to [“Connections – Electrical”](#) on page 72.

Note: Care must be taken when mounting the solar control unit to the side of the solar storage tank. Damage to the cylinder as a result of mounting the solar control unit to the jacket will void the Rheem warranty (refer to [“Saddling - Pipe Work”](#) on page 36).

Cold Sensor: Insert the 5m cold sensor probe into the cold sensor housing, ensuring one ‘O’ ring is in position on the probe. Lock it into position with the locking washer and clip, positioning the clip over the washer and the housing with the ‘ears’ of the washer away from the clip. Refer to diagram on page 67.

INSTALLATION – SOLAR COLLECTORS

Hot and Frost Sensors: The hot sensor and frost sensor leads are supplied as an assembly connecting to the solar controller with a common 4 pin connector.

Hot Sensor Lead: Insert the sensor probe of the **RED** (hot) sensor lead assembly into the sensor connector at the hot outlet of the collector array, ensuring one 'O' ring is in position on the probe. Lock it into position with the locking washer and clip, positioning the clip over the washer and the housing with the 'ears' of the washer away from the clip. Refer to diagram on page 67.

Frost Sensor Lead: Insert the sensor probe of the **WHITE** (frost) sensor lead assembly into the sensor connector at the bottom of the collector array, ensuring one 'O' ring is in position on the probe. Lock it into position with the locking washer and clip, positioning the clip over the washer and the housing with the 'ears' of the washer away from the clip. Refer to diagram on page 67.

Run the hot / frost sensor connector lead cable to the solar control unit and connect to the 4 pin socket located on the underside of the solar control unit, locking it in position. An extension sensor lead(s) is available if the sensor lead is not long enough to reach the solar control unit.

Take precautions to not damage the sensor cable whilst running to the controller due to pinching, sharp metal edges, gang nails, etc.

Cable Ties: Secure the sensor leads at appropriate locations with the cable ties.

Labels: At ground or floor level, adjacent to the site of the solar storage tanks, attach the 'Solar Cold Pipe' label to the insulation on the solar cold pipe to the solar collectors and the 'Solar Hot Pipe' label to the insulation on the solar hot pipe from the solar collectors.

Ensure the arrows on the labels are pointing in the correct direction of water flow.

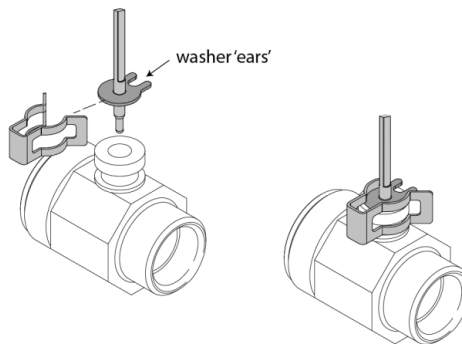

SENSOR CLIP

CONNECTIONS – PLUMBING

IN-SERIES WATER HEATER

The pipe work between the solar storage tank and an in-series water heater must be sized to meet the demands of the premises, **MUST BE** of copper and be fully insulated in accordance with the requirements of AS/NZS 3500.4. The insulation must be weatherproof and UV resistant if exposed. The insulation must be fitted up to the connections on both the solar storage tank and the in-series water heater. An isolation valve must be installed on the water line to the in-series water heater.

SOLAR HOT WATER SECONDARY RETURN

It is possible to return the building secondary return hot water through the solar storage tanks to maximise the amount of solar energy use.

The solar controller can be used to monitor the temperature of water in the solar storage tanks and activate a 3 way motorised valve to divert return water through the solar hot water tanks, if sufficient energy is available, or through the in-series boosters.

3 way motorised valve

The port size of the 3 way motorised valve should be selected to match the building secondary return pipe size.

The valve must have a minimum operating pressure of 1000kPa and be suitable for outdoor installation if installed outdoors.

The direction of flow and wiring of the terminals are linked. It is important that the motorised 3 way valve is installed with flow in the direction as shown in the diagram on page 68 and in accordance with the instructions on page 74 or supplied with the valve.

Contact Rheem technical Advisory Service for information on where to source a suitable 3 way motorised valve.

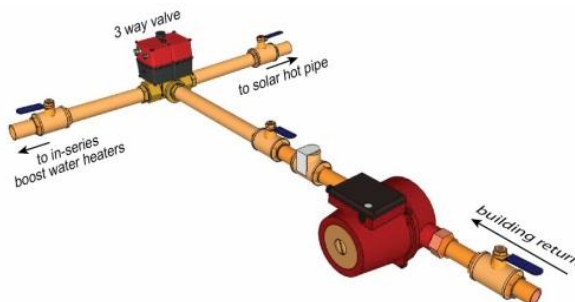

3 WAY VALVE INSTALLATION

CONNECTIONS – PLUMBING

Tank sensor

The tank sensor must be installed if solar hot water secondary return is being used. The controller is supplied with a 5m long sensor lead which connects to the underside of the solar controller. If being used, it will be necessary to remove the 'dummy sensor' from the controller and replace it with the tank sensor. Do not discard the dummy sensor as it is required for commissioning.

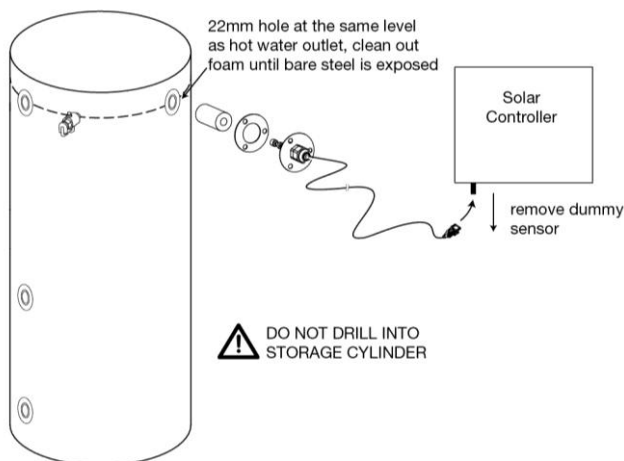

Note: The dummy sensor or tank sensor **MUST** be fitted to the controller to avoid a false fail signal on the controller and/or BMS output.

- Select the solar storage tank located closest to where the controller is positioned.
- Mark the storage cylinder jacket at a point at the same level as the hot water outlet, anywhere on the circumference.
- Using a 22mm diameter hole saw, drill deep enough just to remove the steel jacket outer casing. **Care must be taken to not drill into the storage cylinder.** The insulation thickness is between 47-54mm depending on the tank, and this should be used as a guide. Clean out the remaining foam insulation by hand until clean bare metal is exposed.

CONNECTIONS – PLUMBING

- Ensure the gasket and polystyrene retainer sleeve are fitted to the tank sensor and the plastic cap is removed from the sensor end, then fit the tank sensor to the tank ensuring the sensor end is in contact with the tank jacket.

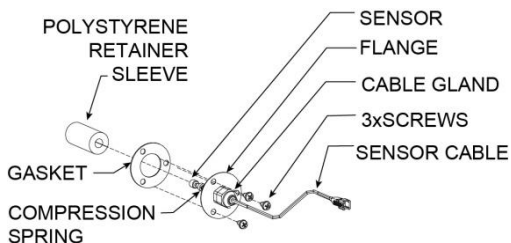

- There should be sufficient tolerance in the spring so that the spring needs to be compressed to bring the flange into contact with the jacket. Screw the flange to the tank jacket with the 3 screws provided.

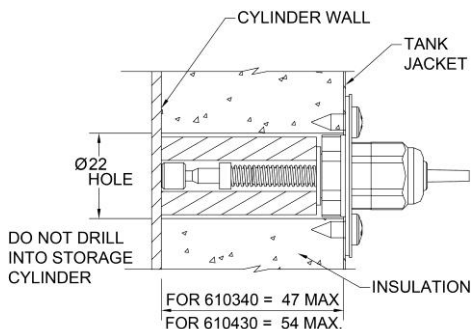

TANK SENSOR FITMENT TO STORAGE TANK

- If the spring length is too long or too short, loosen the cable gland to release the spring tension. Fit the tank sensor to the tank, pressing the flange until it touches the tank jacket, and whilst holding in position, retighten the cable gland. Screw the flange to the tank jacket with the 3 screws provided.
- Remove the 'dummy sensor' from the controller and plug in the tank sensor.
- Secure the sensor lead at appropriate locations with the cable ties.

CONNECTIONS – PLUMBING

Commissioning: Upon completion of the installation, commission the system, including bleeding the air from the solar collectors (refer to “**Bleeding The Solar Collectors**” on page 78) and checking the plumbing and connections for leaks. Refer to “**Commissioning**” on page 78.

Pressure Testing

The solar water heater, including the collector circuit and solar collectors, is to be isolated during the testing and commissioning of the heated water reticulation system in a building, when tested in accordance with Clause 11.1 and 11.3 (a) of AS/NZS 3500.4:2003.

It may be necessary to pressure test the collector circuit to comply with codes and regulatory authority requirements or on other occasions where the solar collectors and solar cold and solar hot pipe work are installed prior to the solar storage tank, such as on a building site.

⚠ Warning: The pressure applied to the solar circuit and solar collectors during a pressure test of a direct open circuit system **MUST NOT** exceed 1000 kPa where NPT200 solar collectors are installed, otherwise damage may result to the solar collectors.

If the solar collectors, solar pipe work and solar storage tank are installed and commissioned together, then the flooding of the collector circuit with water under mains pressure and checking for leaks during the commissioning procedure can be substituted for the pressure testing of the collector circuit.

CONNECTIONS – ELECTRICAL

WARNING:

The power supply to the solar control unit and auxiliary electric heater, if installed, must not be switched on until the solar storage tanks, auxiliary electric heater and solar collectors are filled with water and a satisfactory megger reading is obtained. The solar water heating system is designed so the solar storage tanks do not have power connected to them.

All electrical work and permanent wiring must be carried out by a qualified person and in accordance with the Wiring Rules AS/NZS 3000 and local authority requirements.

SOLAR CONTROL UNIT

The solar control unit, supplied with a 1.8 metre power cord, requires a 240 V 50 Hz general purpose outlet (GPO) to be located within 1.2 metres of its location. The GPO must have a continuous power supply. The GPO is required to be weatherproof if installed outdoors.

The solar control unit draws 4 Watts of power as a constant load.

CAUTION: DO NOT REMOVE GROMMETS FROM UNDERNEATH CONTROLLER UNLESS THEY ARE TO BE USED FOR AUXILIARY FUNCTIONS

CONNECTIONS – ELECTRICAL

Wiring Diagram – Solar Control Unit

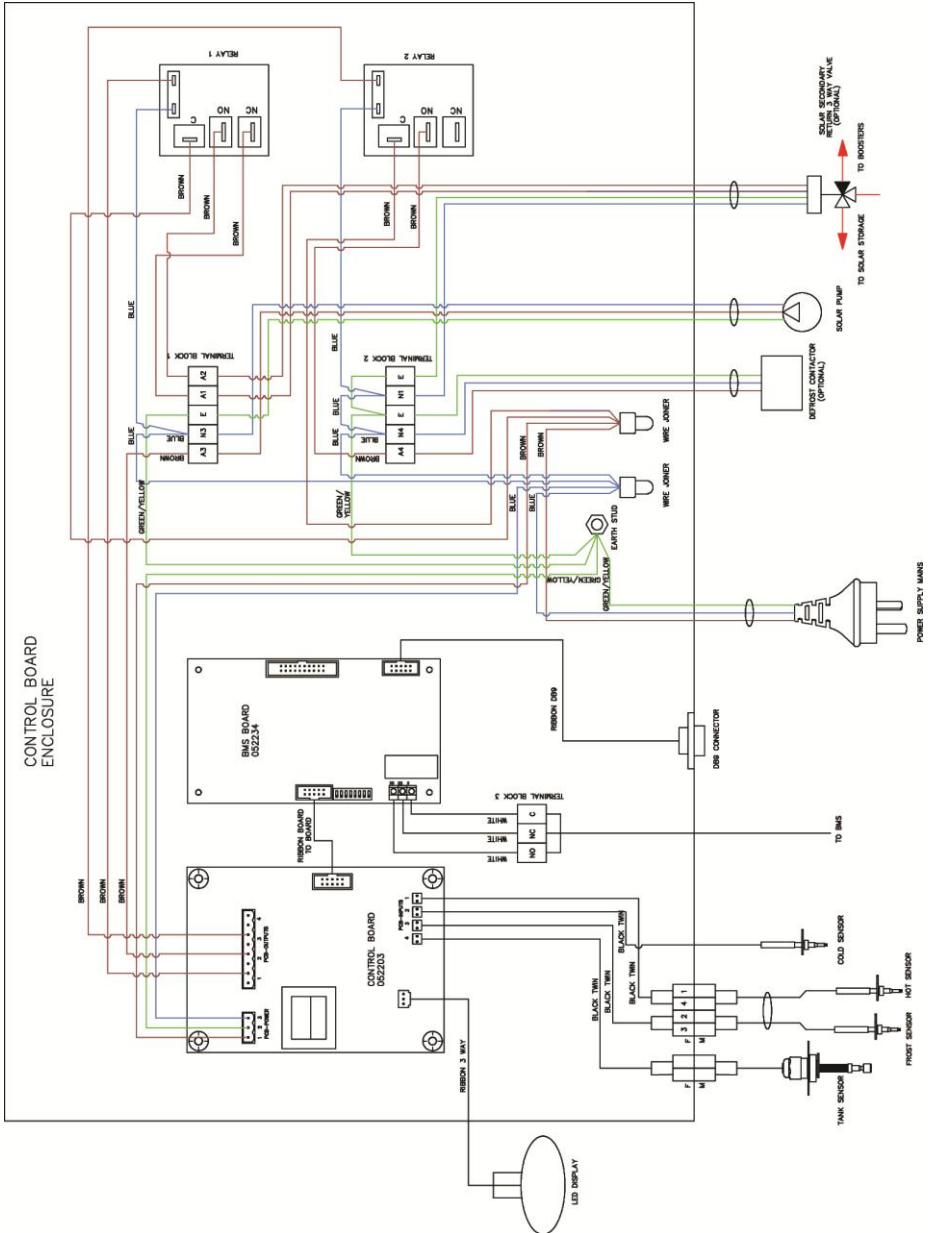

CONNECTIONS – ELECTRICAL

SOLAR CIRCULATOR/S

Connect the solar circulator(s) to the solar controller at the terminals A₃, N₃, E marked 'SOLAR PUMP' as shown in the [diagram on page.74](#). A flexible 20 mm conduit is required for the electrical cable from the solar control unit to the circulator(s). The conduit is to be connected to the solar control unit and circulator(s) with a 20 mm terminator.

A dual circulator system such as Redi-set can be controlled by the solar controller.

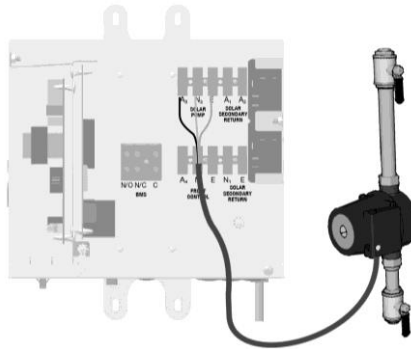

AUXILIARY ELECTRIC HEATER

The power supply to the auxiliary electric heater must not be switched on until the water heater is filled with water and a satisfactory megger reading is obtained.

The auxiliary electric heater is required if the installation is subject to frost conditions. It must be connected to either a 240V AC 50 Hz mains power supply or a 3 phase, 415 Volt AC star supply via a contactor of suitable rating (not supplied).

The contactor must be installed in a suitable enclosure (not supplied) with appropriate conduit for running cabling as follows:

- From the Solar Controller to the enclosure;
- From the switchboard to the enclosure;
- From the enclosure to the Auxiliary Electric Heater.

CONNECTIONS – ELECTRICAL

The power rating of the heating unit(s) is shown on the rating label of the auxiliary electric heater. An isolating switch must be installed at the switchboard.

Note: The auxiliary electric heater, if supplied by Rheem, is not suitable for power supplies utilising a 415 V delta connected supply.

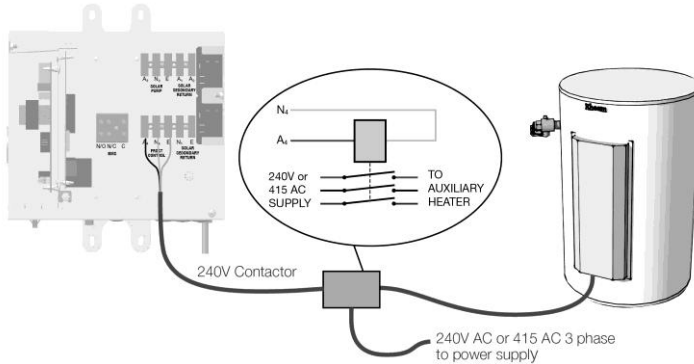

The connections at the auxiliary electric heater should be made in accordance with the installation instructions for the heater.

Connect the coil of the contactor to the solar controller at the terminals A₄, N₄, E marked 'FROST CONTROL' as shown in the [diagram on page 74](#).

CONNECTIONS – ELECTRICAL

SOLAR HOT WATER SECONDARY RETURN

Connect the 3 way motorised valve to the solar controller at the terminals A₁, A₂, N₁, E marked 'SOLAR SECONDARY RETURN' as shown in the diagram on page 76 and in accordance with the installation instructions supplied with the 3 way valve. A 20 mm conduit is required for the electrical cable from the solar control unit to the 3 way valve. The conduit is to be connected to the solar control unit with a 20 mm terminator and at the 3 way valve with a terminator appropriate for the 3 way valve.

The wiring of the 3 way valve is to be such that water is diverted to the solar storage tanks when A₂ is energised.

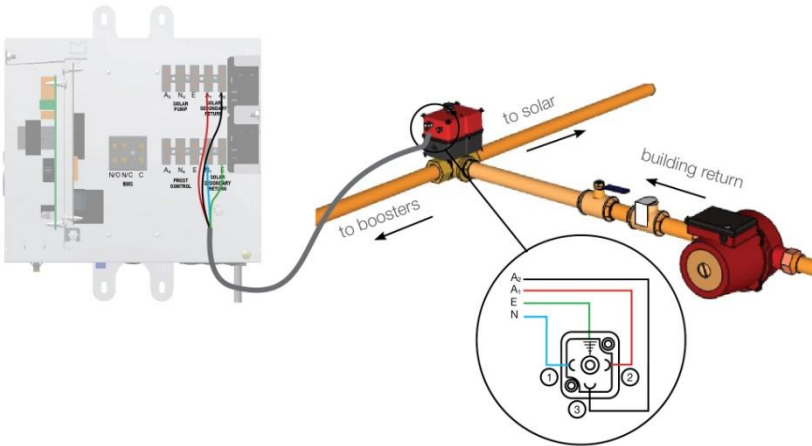

THERMOSTAT SETTING

For reasons of safety and economy, we advise the thermostats on the booster water heaters and auxiliary electric heater be set at the lowest temperature that will provide sufficient hot water during periods when boosting is required. We recommend the thermostats are set at 60°C to maximise solar contribution. This is especially important if the Solar Hot Water Secondary Return option is being employed. Discuss the thermostat setting with a responsible officer.

CONNECTIONS – ELECTRICAL

BUILDING MANAGEMENT SYSTEM (BMS)

A BMS system can be connected to the solar controller to indicate normal operation or fault mode. Normal operation includes both run mode and standby mode

Connect the BMS system to the solar controller at the terminals N/O, N/C, C marked 'BMS' as appropriate. Refer to the diagram on page 77.

A circuit between:

N/O and C= NORMAL OPERATION

N/C and C = FAULT

The BMS outputs are voltage free with a current carrying capacity of 1 Amp at 240V AC 50Hz resistive load.

A 20 mm conduit is required for the BMS cable from the solar control unit to the BMS. The conduit is to be connected to the solar control unit with a 20 mm terminator and at the BMS as appropriate.

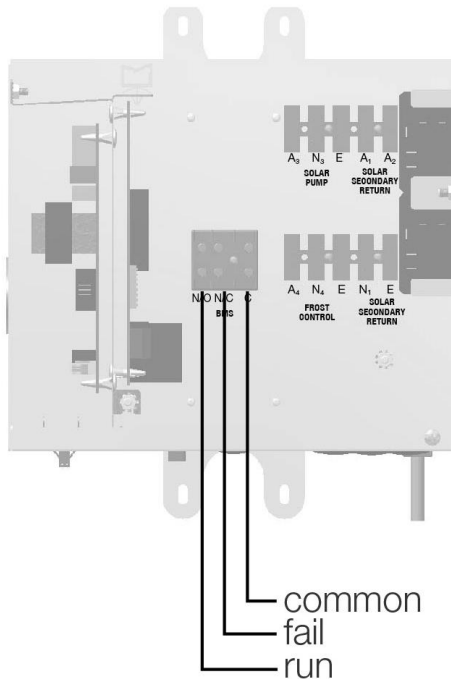

COMMISSIONING

TO FILL AND TURN ON THE WATER HEATER



Warning: The power supply to the solar control unit and circulator(s) must not be switched on until the solar storage tanks and solar collectors are filled with water and a satisfactory megger reading is obtained. Ensure the circulator isolation valves are open.

- This procedure is applicable to filling the water heaters only and does not necessarily cover charging of the building circuit. Where practical, open ALL hot water taps in the building and supply cocks and valves in the system. Where this is not practical, open taps closest to the water heating system.
- Open the isolation valves fully on the cold water, solar hot and hot water branches on the solar storage tanks installed in a bank.

Open the cold water isolation valve on the cold water line to the solar storage tanks. Air will be forced out of the taps.

- Close each tap as water flows freely from it.
- Check the pipe work for leaks.

BLEEDING THE SOLAR COLLECTORS

- Upon completion of the installation, it is necessary to purge the air from the collector circuit. This procedure will purge large quantities of air from the collector circuit. Any remaining air will be purged from the system through the automatic air eliminator valves installed at the highest points of the collector circuit.

To purge air from the collector circuit:

- Ensure the solar storage tanks are full of water, all of the hot taps are turned off and all isolation valves on the solar tanks, solar pump(s) and auxiliary electric heater (if installed) are open.
- Open the drain valve installed in the solar hot pipe (flow from collector).
- The mains pressure will force water to flow from the solar storage tanks and through the pipe work, forcing air from the collector circuit through the drain valve.

This is evidenced by spurting of water from the drain line connected to the drain valve.

Warning: Exercise care to avoid any splashing of water, as water discharged from the solar collectors may be of a very high temperature.

Close the drain valve when water runs freely from the drain line.

COMMISSIONING

SYSTEM START UP

Plug in the solar control unit at the power outlet and switch on the electrical supply.

- When the electrical supply is switched on to the solar control unit, flashes may be observed on the solar control unit LED, as follows:
- If there is insufficient temperature difference between the hot and cold sensors, the circulator will not activate and the green LED will emit one long flash every four (4) seconds.

The long flash indicates the circulator is not activated and the power to the solar control unit has been on for less than 48 hours.

- If there is sufficient temperature difference between the hot and cold sensors, the circulator activates and the green LED emits a group of three (3) short flashes every four (4) seconds.

The three (3) flashes indicate the circulator is operating and power to the solar control unit has been on for less than 48 hours.

- If the temperature difference between the hot and cold sensors is greater than 45°C, the red LED emits flashes at a rate of one per second. This is not necessarily a fault code, but is a result of an increase in the collector temperature prior to switching the controller on. No fault signal will be registered on the BMS.

The flashing of the red LED will cease as the water circulates and the heat in the collectors is dissipated. This should be within four (4) to five (5) minutes of start up, but may take up to ten (10) minutes.

If the flashing of the red LED continues for more than ten (10) minutes, this may indicate water is not circulating through the collectors and solar circuit. In this case:

- Check operation of the solar circulator(s)
- Switch off the electrical supply at the power outlet to the solar control unit
- Bleed the solar collectors

Switch on the electrical supply at the power outlet to the solar control unit.

COMMISSIONING

DIAGNOSTIC FEATURES OF THE SOLAR CONTROLLER

A solar monitor is located on the side of the solar control unit and houses a green and a red LED.

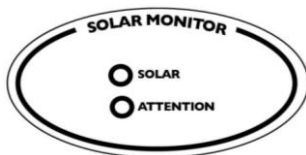

The green LED, marked “Solar”, indicates the current operational mode of the solar water heater and the red LED, marked “Attention”, indicates a fault mode.

The green LED will emit either a constant glow or a group of flashes, with a 2 second interval between each group.

The red LED will emit a group of flashes, with a 2 second interval between each group, only if there is a particular fault condition with the system.

The modes are:

Flashes	Operational Modes
solid green (remains on)	Standby mode
green 3 second flash	Standby mode (power on for less than 48 hours)
green 1 second intervals	Circulating water through collectors
3 x green	Circulating water through collectors (power on for less than 48 hours)
no green (remains off)	Power outage or call for service
Flashes	Fault Modes
3 x red	Hot sensor in collector – short circuit
4 x red	Hot sensor in collector – open circuit
5 x red	Cold sensor –short circuit
6 x red	Cold sensor – open circuit
solid red (remains on)	Hot sensor temperature greater than 130°C
red 1/2 second on, 1/2 second off	Temperature rise across collector greater than 45°C (indicator of possible pump failure if on for more than 10 minutes)
red twice every 4 seconds	Frost sensor in collector – fault
red three times every 4 seconds	Tank sensor - fault

COMMISSIONING

If the power supply to the solar control unit is on and the green LED is off or the red LED is flashing, this indicates there may be a fault with the water heating system. The red LED may emit up to six flashes in each group of flashes.

Note: During periods of high solar radiation and if the circulator activates after having been off, such as during start up, it is possible the red LED may emit flashes at a rate of one per second for a period of up to ten (10) minutes. This does not necessarily indicate a fault. Refer to "Initialising the System" on page 79 for the possible green and red LED flashing sequence during start up procedure.

If the red LED continues to flash for longer than ten (10) minutes, or emits groups of flashes, then count the number of flashes and phone Rheem Service or their nearest Accredited Service Agent to arrange for an inspection.

BMS

If a BMS system has been connected to the solar controller BMS output, a fault signal will be generated whenever the Solar Monitor 'ATTENTION' indicator is flashing or displaying red, or if the power supply to the solar controller has been interrupted. The exception is flashing at a rate of one per second, in which a delay will occur before the BMS will output a fault mode.

A normal mode signal will be generated whenever the Solar Monitor 'SOLAR' indicator is flashing or displaying green. The BMS does not distinguish between standby and run mode.

⚠ Warning: This procedure exposes the installer to dangerous voltages. Work must only be carried out by a suitably qualified person and suitable safety precautions must be observed.

To check correct connection of BMS:

- Normal Operation - When the system is first energised the green LED should be illuminated and there should be a closed circuit between N/O and Common.
- Fault Mode - It will be necessary to simulate a fault. Remove the dummy sensor or tank sensor located on the underside of the solar control unit. The red LED should flash three times every 4 seconds and there should be a closed circuit between N/C and Common.
- Replace the dummy sensor or tank sensor.

COMMISSIONING

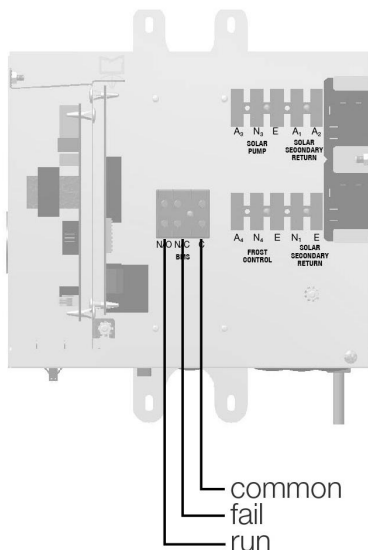

SOLAR SECONDARY RETURN

The direction of flow and wiring of the terminals of the 3 way motorised valve are linked. It is important that the motorised 3 way valve is installed with flow in the direction as shown in the diagram on page 76 and in accordance with the instructions on page 74 or supplied with the valve.

⚠ Warning: This procedure exposes the installer to dangerous voltages. Work must only be carried out by a suitably qualified person and suitable safety precautions must be observed.

To check correct operation:

1. Either unplug the Tank Sensor at the solar control unit and replace it with the Dummy Sensor, or remove the Tank Sensor from the storage tank by undoing the 3 screws holding the tank sensor plate in position. If the latter is chosen, place the sensor in such a way as to sense ambient air.

Note: either method will ensure the controller behaves as if the solar storage tank temperature is below the ON set point for solar secondary recirculation, ie should be directing water to the booster plant.

2. Check the voltage at A1 to Neutral and A2 to Neutral in the solar control unit. In the test mode, there should be 240V AC at A1 and 0V AC at A2.

COMMISSIONING

3. The Rheem recommended motorised valve has a yellow indicator and open and closed logos moulded into the housing.

In the test mode, the indicator should be pointing to 'CLOSED'.

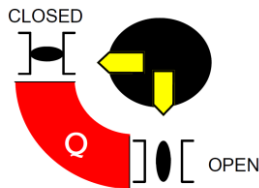

Q = Working quadrant

The following parameters need to be checked and adjustments made, if required:

Plumbing Arrangement	3 Way Valve Position	Result	Action
	Closed	Return water diverted to booster	No action required
	Open	Return water diverted to solar	Reverse wiring at A1 and A2
	Closed	Return water diverted to solar	Reverse wiring at A1 and A2
	Open	Return water diverted to booster	No action required

BOOSTER WATER HEATERS

Commission the booster water heaters in accordance with the installation instructions supplied with the water heaters.

Explain to a responsible officer the functions and operation of the solar water heater. Upon completion of the installation and commissioning of the water heater, leave this guide with a responsible officer.

SYSTEM SHUTDOWN

TO TURN OFF THE WATER HEATING SYSTEM

If it is necessary to turn off the water heating system on completion of the installation, such as on a building site or where the premises are vacant, then:

- Switch off the electrical supply at the power outlet to the solar control unit (refer to note below).
- Close the cold water isolation valve on the cold water line to the solar storage tanks to shut down the entire system, or;
- Close the isolation valves on the cold, solar hot and hot water branches to shut down an individual solar storage tank in a bank, or;
- Close an isolation valve at each circulator and close the isolation valves on the solar hot branches to the solar storage tanks to isolate the solar collectors only.
- Open the solar cold pipe and solar hot pipe drain isolation valve. 
Warning: The solar collectors should only be isolated if a solar **cold pipe** drain isolation valve and solar **hot pipe** drain isolation valve are installed and both of them are opened. This will prevent both wet stagnation conditions in the solar collectors under solar radiation and prevent the risk of the water freezing in the solar collectors if freezing conditions were to occur (refer to “[Draining The Solar Collectors](#)” on page 85).

Note: The freeze protection system will be rendered inoperable if electrical power is not available. Damage caused by freezing due to the unavailability of power to the solar control unit, circulator(s) and auxiliary electric heater is not covered by the Rheem warranty (on page 90. If there is a risk of freezing, then it is necessary to drain the solar collectors and connecting pipe work (refer to “[Draining the Solar Collectors](#)” on page 85).

DRAINING THE SOLAR COLLECTORS

To drain the solar collectors and the solar hot and solar cold pipes:

- Open a hot water tap and allow the water to run for five minutes immediately prior to draining the solar collectors. This will assist in the transfer of any high temperature water in the solar collectors to the solar storage tanks.

To isolate the collector circuit from the storage tanks:

- Switch off the electrical supply at the power outlet to the solar control unit and circulator(s).
- Close the isolation valve on the outlet side of each circulator.
- Open the air bleed valve fitted adjacent to the solar hot pipe (flow from collectors).
- Water will now drain from the solar hot pipe.

⚠ Warning: Exercise care, as water discharged from the solar collectors may be of a very high temperature.

- The non return valve on the solar hot pipe will prevent back flow from the solar storage tanks.
- Close the isolation valve(s) on the solar hot branches to the solar storage tanks.

⚠ Warning: It is important to open the air bleed valve prior to closing the isolation valves on the storage tanks. If solar radiation is available, the water will be heated in the solar collectors causing the water to expand. This thermal expansion will be expelled through the open air bleed valve.

- Open the solar cold pipe drain isolation valve fitted adjacent to the solar cold pipe (flow to collectors).
- Water will now drain from the solar collectors and the solar cold pipe.

To open the solar circuit to the solar storage tanks:

- Close the solar cold pipe drain isolation valve fitted adjacent to the solar cold pipe (flow to collectors).
- Open the isolation valves on the solar flow branches to the solar storage tanks.
- Close the air bleed valve fitted adjacent to the solar hot pipe (flow from collectors).
- Open the isolation valve on the outlet side of each circulator and switch on the electrical supply to the solar control unit.

DRAINING THE SOLAR STORAGE TANK

To drain the solar storage tank:

- Open a hot water tap and allow the water to run for five minutes immediately prior to **draining** the solar storage tank.

This will assist in the transfer of any high temperature water in the solar collector(s) to the solar storage tank.

- Close the hot water tap.

⚠ Warning: Exercise care, as water discharged from the solar storage tank may be at a very high temperature.

- Switch off the electrical supply at the power outlet to the solar control unit and circulator(s) if the solar storage tank is not installed in a bank of solar storage tanks.
- Turn off and isolate the solar storage tank (refer to “**To Turn Off The Water Heater**” on page 84).
- Operate the relief valve release lever - do not let the lever snap back or you will damage the valve seat.

Operating the lever will release the pressure in the solar storage tank.

- Undo the union at the cold water inlet to the solar storage tank and attach a hose to the solar storage tank side of the union.

Let the other end of the hose go to a drain.

- Operate the relief valve again.

This will let air into the solar storage tank and allow the water to drain through the hose.

This page is left intentionally blank

This page is left intentionally blank

This page is left intentionally blank

RHEEM SOLAR WATER HEATER WARRANTY – AUSTRALIA ONLY

COMMERCIAL SOLAR LOLINE WATER HEATER

Collectors NPT200 & L, Storage tanks 610340 & 610430

Solar controller unit 299303

1. THE RHEEM WARRANTY – GENERAL

- 1.1 This warranty is given by Rheem Australia Pty Limited ABN 21 098 823 511 of 1 Alan Street, Rydalmere New South Wales.
- 1.2 Rheem offer a trained and qualified national service network who will repair or replace components at the address of the water heater subject to the terms of the Rheem warranty. Rheem Service, in addition can provide preventative maintenance and advice on the operation of your water heater. The Rheem Service contact number is available 7 days a week on 131 031 with Service personnel available to take your call from 8am to 8pm daily (hours subject to change).
- 1.3 For details about this warranty, you can contact us on 131 031 or by email at warrantyenquiry@rheem.com.au (not for service bookings).
- 1.4 The terms of this warranty and what is covered by it are set out in section 2 and apply to water heaters manufactured after June 2014.

If a subsequent version of this warranty is published, the terms of that warranty and what is covered by it will apply to water heaters manufactured after the date specified in the subsequent version.

2. TERMS OF THE RHEEM WARRANTY AND EXCLUSIONS TO IT

- 2.1 The decision of whether to repair or replace a faulty component is at Rheem's sole discretion.
- 2.2 Where a failed component or cylinder is replaced under this warranty, the balance of the original warranty period will remain effective. The replacement does not carry a new Rheem warranty.
- 2.3 Where the water heater is installed outside the boundaries of a metropolitan area as defined by Rheem or further than 25 km from either a regional Rheem branch office or an Accredited Rheem Service Agent's office, the cost of transport, insurance and travelling between the nearest branch office or Rheem Accredited Service Agent's office and the installed site shall be the owner's responsibility.
- 2.4 Where the water heater is installed in a position that does not allow safe or ready access, the cost of that access, including the cost of additional materials handling and/or safety equipment, shall be the owner's responsibility. In other words, the cost of dismantling or removing cupboards, doors or walls and the cost of any special equipment to bring the water heater to floor or ground level or to a serviceable position is not covered by this warranty.
- 2.5 This warranty only applies to the original and genuine Rheem water heater in its original installed location and any genuine Rheem replacement parts.
- 2.6 If the water heater is not sized to supply the hot water demand in accordance with the guidelines in the Rheem water heater literature, any resultant fault will not be covered by the Rheem warranty.
- 2.7 The Rheem warranty does not cover faults that are a result of:
 - a) Accidental damage to the water heater or any component (for example: (i) Acts of God such as floods, storms, fires, lightning strikes and the like; and (ii) third party acts or omissions).
 - b) Misuse or abnormal use of the water heater.
 - c) Installation not in accordance with the Owner's Guide and Installation Instructions or with relevant statutory and local requirements in the State or Territory in which the water heater is installed.

- d) Connection at any time to a water supply that does not comply with the water supply guidelines as outlined in the Owner's Guide and Installation Instructions.
 - e) Repairs, attempts to repair or modifications to the water heater by a person other than Rheem Service or a Rheem Accredited Service Agent.
 - f) Faulty plumbing or faulty power supply.
 - g) Failure to maintain the water heater in accordance with the Owner's Guide and Installation Instructions.
 - h) Transport damage.
 - i) Fair wear and tear from adverse conditions (for example, corrosion).
 - j) Cosmetic defects.
 - k) Ice formation in the waterways of a water heating system incorporating a freeze protection system: where the electricity supply has been switched off or has failed; or where the solar pipe work has not been adequately insulated; or where the frost sensor has not been correctly installed; or where the auxiliary electric water has not been installed; or where it is installed at an altitude more than 400 metres above sea level.
 - l) Breakage of collector glass for any reason including hail damage (we suggest that the collector glass be covered by your home insurance policy).
- 2.8 If you require a call out and we find that the fault is not covered by the Rheem warranty, you are responsible for our standard call out charge. If you wish to have the relevant component repaired or replaced by Rheem, that service will be at your cost.
- 2.9 Subject to any statutory provisions to the contrary, this warranty excludes any and all claims for damage to furniture, carpet, walls, foundations or any other consequential loss either directly or indirectly due to leakage from the water heater, or due to leakage from fittings and/ or pipe work of metal, plastic or other materials caused by water temperature, workmanship or other modes of failure.

3. WHAT IS COVERED BY THE RHEEM WARRANTY FOR THE WATER HEATERS DETAILED IN THIS DOCUMENT

- 3.1 Rheem will repair or replace a faulty component of your water heater if it fails to operate in accordance with its specifications as follows:

What components are covered	The period from the date of installation in which the fault must appear in order to be covered	What coverage you receive
All components	Year 1	Repair and/or replacement of the faulty component, free of charge, including labour.
The cylinder (if the water heater is installed in a single-family domestic dwelling)	Years 2 to 5	Repair and / or replacement of the cylinder, free of charge, including labour.
	Years 6 to 10	Replacement cylinder, free of charge. Installation and repair labour costs are the responsibility of the owner.
The cylinder (if the water heater is <u>not</u> installed in a single-family domestic dwelling)	Years 2 to 5	Replacement cylinder, free of charge. Installation and repair labour costs are the responsibility of the owner.
The solar collector (all installations)	Years 2 to 5	Replacement solar collector, free of charge. Installation and repair labour costs are the responsibility of the owner.

- 3.2 For Wilson stainless steel tanks warranty refer to Wilson tank owner's guide.
- 3.3 If a government rebate has been received for the water heater, the duration of the protection afforded by this warranty may be greater than what is set out above. Please call 131 031 for details.

4. ENTITLEMENT TO MAKE A CLAIM UNDER THIS WARRANTY

- 4.1 To be entitled to make a claim under this warranty you need to:
 - a) Be the owner of the water heater or have consent of the owner to act on their behalf
 - b) Contact Rheem Service without undue delay after detection of the defect and, in any event, within the applicable warranty period.
- 4.2 You are **not** entitled to make a claim under this warranty if your water heater:
 - a) Does not have its original serial numbers or rating labels.
 - b) Is not installed in Australia.

5. HOW TO MAKE A CLAIM UNDER THIS WARRANTY

- 5.1 If you wish to make a claim under this warranty, you need to:
 - a) Contact Rheem on 131031 and provide owner's details, address of the water heater, a contact number and date of installation of the water heater or if that's unavailable, the date of manufacture and serial number (from the rating label on the water heater)
 - b) Rheem will arrange for the water heater to be tested and assessed on-site.
 - c) If Rheem determines that you have a valid warranty claim, Rheem will repair or replace the water heater in accordance with this warranty
- 5.2 Any expenses incurred in the making of a claim under this warranty will be borne by you.

6. THE AUSTRALIAN CONSUMER LAW

- 6.1 Our goods come with guarantees that cannot be excluded under the *Australian Consumer Law*. You are entitled to a replacement or refund for a major failure and for compensation for any other reasonably foreseeable loss or damage. You are also entitled to have the goods repaired or replaced if the goods fail to be of acceptable quality and the failure does not amount to a major failure.
- 6.2 The Rheem warranty (set out above) is in addition to any rights and remedies that you may have under the *Australian Consumer Law*.

RHEEM AUSTRALIA PTY LTD
A.B.N. 21 098 823 511
www.rheem.com.au

FOR SERVICE TELEPHONE
131 031 AUSTRALIA
0800 657 335 NEW ZEALAND